

TM 31-200-1

DEPARTMENT OF THE ARMY TECHNICAL MANUAL

UNCONVENTIONAL WARFARE DEVICES AND TECHNIQUES

REFERENCES



HEADQUARTERS, DEPARTMENT OF THE ARMY
APRIL 1966

TECHNICAL MANUAL }
 No. 31-200-1

HEADQUARTERS
 DEPARTMENT OF THE ARMY
 WASHINGTON, D.C., 5 April 1966

Unconventional Warfare Devices and Techniques

REFERENCES

	Section	Page
INTRODUCTION	2
CHAPTER 00. INCENDIARY SYSTEMS		
Igniters	01	4
Incendiaries	02	11
Delay Mechanisms	03	23
Spontaneous Combustion	04	30
10. EXPLOSIVES		
Initiators	11	34
Low Explosives	12	39
Primary High Explosives	13	40
Secondary High Explosives	14	41
Techniques and Precautions	15	48
Gas and Dust Explosives	16	48
20. APPLICATIONS OF EXPLOSIVES		
Basic Demolition Techniques	21	50
Demolition Charges	22	51
Fuses	23	66
Fuzes	24	67
Firing Devices	25	76
Firing Switches	26	94
Boobytraps	27	108
Mines	28	129
Other Explosive Ordnance	29	150
30. SMALL ARMS		
Ballistics and Penetration	31	167
Weapons	32	168
Ammunition	33	180
40. HARMFUL ADDITIVES—CHEMICAL MATERIALS		
Corrosive Materials	41	182
Abrasive Materials	42	184
Clogging Materials	43	185
Other Contaminants	44	214
INDEX	225

INTRODUCTION

This manual is one of a series now being published, primarily for U.S. Army Special Forces, that deals with subjects pertaining to destructive techniques and their applications to targets in guerrilla and unconventional warfare. Unconventional Warfare Devices and Techniques manuals present the principles of construction and methods of use of devices and techniques that are proven reliable and effective. Unconventional Warfare Target manuals identify critical components of selected targets and describes techniques for destruction of the target using applicable devices and techniques. This manual on references to unconventional warfare devices and techniques contains more than 400 abstracts on the subject. Both classified and unclassified manuals are published in the series.

This technical manual is written to serve two groups of Special Forces readers. First, it is designed to assist research and development personnel by collecting in one place abstracts of new and existing information dealing with the subject. As a survey of what has been accomplished in the past, it can assist in avoiding duplications of effort. Second, it furnishes information to the men in the field. The collection of ideas may themselves have applications and, more important, can act as thought-starters to help apply a technique or device to a new situation.

To serve these purposes best, the abstracts that make up this manual are written in what is called the informative style. That is, they are self-sufficient. They are carefully compiled and illustrated to give enough details for the reader to understand the purposes, tests, and results of the particular subject matter. The source report will be required only when an in-depth study is planned. The report or document from which the abstract was prepared is cited for this purpose.

The references in this manual are grouped into the following five chapters:

00. Incendiary Systems
10. Explosives
20. Applications of Explosives
30. Small Arms
40. Harmful Additives—Chemical Materials

Each chapter is subdivided according to this numbering convention:

Chapter No.

Sequential Section No.

Sequential Abstract No.

00-01

This numbering system was selected to make location of material convenient for the reader, once he has become familiar with the arrangement. For the same reason, each abstract is written in a uniform format: name of item, description (an illustration is included when useful), comments (on tests and effectiveness), and source reference.

The references selected for inclusion in this manual resulted from a comprehensive search of the available literature. The collection in this series is believed to cover the bulk of the pertinent subject matter. Those subjects not yet fully covered will be treated in a future manual (classified or unclassified). Engineering judgement was applied under *Comments* when first-hand knowledge of test data or reliability of an item was lacking. In case of question, the original reference must be consulted.

It is anticipated that this manual will be revised or changed from time to time. In this way it will be possible to update present material and add new devices and techniques as they become available. In addition to the chapter on Harmful Additives—Chemical Materials, it is planned to include a chapter on Harmful Additives—Biological Materials as well. Comments are welcome and the submission of new information for a subsequent edition is encouraged. Address information to Commanding Officer, U.S. Army, Frankford Arsenal, SMUFA-U3200, Philadelphia, Pa., 19137.

CHAPTER 00. INCENDIARY SYSTEMS

Section 01. IGNITERS

SUGAR—SODIUM PEROXIDE IGNITER

01-1

Description: This igniter is a mixture of equal quantities of sodium peroxide and granulated sugar. It is used to ignite incendiaries and readily flammable material such as rags, dry paper, dry hay, or the combustible vapor above liquid fuels. It can be initiated by a fuse cord, concentrated sulfuric acid, or water.

Comments: This material was tested. It is effective.

Caution: This mixture is unstable and may ignite under conditions of high humidity or when wetted by drops of water or perspiration. The mixture should not be stored for longer than three days, as decomposition may occur and cause spontaneous combustion.

Reference: TM 31-201-1, Unconventional Warfare Devices and Techniques, para 0203.

ALUMINUM POWDER—SODIUM PEROXIDE IGNITER

01-2

Description: This igniter is a mixture of equal quantities of sodium peroxide and aluminum powder. It is used to ignite incendiaries and readily flammable material such as rags, dry paper, dry hay, or the combustible vapor above liquid fuels. It can be initiated by a fuse cord, concentrated sulfuric acid, or water.

Comments: This material was tested. It is effective.

Caution: This mixture is unstable and may ignite under conditions of high humidity or when wet by drops of water or perspiration. The mixture should not be stored for longer than three days, as decomposition may occur and cause spontaneous combustion.

Reference: TM 31-201-1, Unconventional Warfare Devices and Techniques, para 0204.

SUGAR—CHLORATE IGNITER

01-3

Description: The igniter is a mixture of equal quantities of granulated sugar and potassium chlorate or granulated sugar and sodium chlorate. Initiation by fuse cord is recommended. This mixture is used to ignite

long-burning chemical incendiaries or readily flammable material, such as rags, dry paper, dry hay, or the combustible vapor above liquid fuels.

Comments: This material was tested. It is effective.

Caution: Although this mixture looks like granulated sugar, it is poisonous and must not be eaten.

Reference: TM 31-201-1, Unconventional Warfare Devices and Techniques, para 0201.

FIRE FUDGE IGNITER

01-4

Description: This igniter is a solution of granulated sugar (1 part) and potassium chlorate (2 parts) in hot water (1 part). It can be poured into molds, and solidifies when cooled to room temperature. It resembles white sugar fudge and has a smooth, hard surface. This mixture is used to ignite incendiaries and readily flammable material such as rags, dry paper, dry hay, or the combustible vapor area above liquid fuels. This igniter can be initiated by a fuse cord or concentrated sulfuric acid.

Comments: This material was tested. It is effective.

Caution: Although this mixture resembles fudge, it is poisonous and must not be eaten.

Reference: TM 31-201-1, Unconventional Warfare Devices and Techniques, para 0202.

IGNITER FROM BOOK MATCHES

01-5

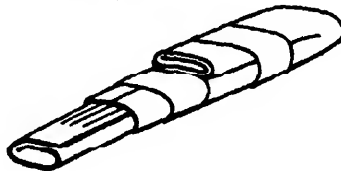

Description: This device is a high heat igniter made from a book of paper matches. The matches are first separated from the cover and one row is folded and taped. The cover is then shaped into a tube with the striking surface on the inside. The striking end is taped and the opposite end left open for inserting the packet of matches. The matches and cover are arranged so that the striking surface scrapes against and ignites the matches as the cover is pulled away. In practice, only the matches are fastened to the incendiary, leaving the cover free to act as a pull tab.

Comment: This item was tested. It is effective.

Reference: TM 31-210, Improvised Munitions, sec V, No. 2.

FUSE IGNITER FROM BOOK MATCHES

01-6

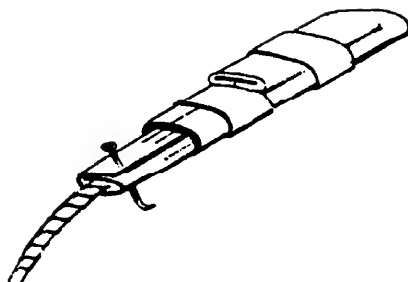

Description: This device is a fuse igniter made from a book of paper matches, fuse cord, a pin or small nail, and adhesive tape. The matches are separated from the cover. The fuse cord is cut to expose the inner core and is attached in the center of one row of matches which is then folded over and taped. The pin or small nail is used to hold the matches and fuse cord together. The cover is shaped into a tube with the striking surface on the inside. The striking end is taped and the opposite end left open for inserting the matches and fuse cord. The matches and cover are arranged so that the striking surface scrapes against and ignites the matches that in turn ignite the fuse cord as the cover is pulled away.

Comments: This item was tested. It is effective.

Reference: TM 31-210, Improvised Munitions, sec VI, No. 2.

SILVER NITRATE—MAGNESIUM POWDER IGNITER

01-7

Description: This igniter is a mixture of silver nitrate crystals and magnesium powder. It is used to ignite incendiaries and readily flammable materials such as rags, dry paper, dry hay, or the combustible vapor area above liquid fuels. It can be initiated by a fuse cord, concentrated sulfuric acid, or water.

Comments: This material was tested. It is effective.

Caution: This mixture is unstable and may ignite under conditions of high humidity or when wet by drops of water or perspiration. Direct sunlight may cause decomposition of the silver nitrate and make the igniter ineffective.

Reference: TM 31-201-1, Unconventional Warfare Devices and Techniques, para 0208.

WHITE PHOSPHOROUS IGNITER

01-8

Description: This igniter consists of white phosphorous dissolved in carbon disulfide. It is used to ignite incendiaries and readily flammable

materials such as rags, dry paper, dry hay, or the combustible vapor above liquid fuels. Ignition occurs when the carbon disulfide evaporates and the white phosphorous comes in contact with air.

Comments: This material was tested. It is effective.

Caution: This mixture should not be stored in direct sunlight for more than three days as it may deteriorate. This igniter is not reliable at near freezing temperatures (32° F.). Do not permit white phosphorous to touch the skin as painful burns may result. Carbon disulfide fumes are poisonous. Adequate ventilation is required when mixing.

Reference: TM 31-201-1, Unconventional Warfare Devices and Techniques, para 0209.

MAGNESIUM POWDER—BARIUM PEROXIDE IGNITER 01-9

Description: This igniter consists of finely powdered magnesium and finely powdered barium peroxide. It is used to ignite incendiaries and readily flammable materials such as rags, dry paper, dry hay, or the combustible vapor above liquid fuels. It can be initiated by a fuse cord.

Comments: This material was tested. It is effective.

Reference: TM 31-201-1, Unconventional Warfare Devices and Techniques, para 0210.

SUBIGNITER FOR THERMITE 01-10

Description: This igniter is a mixture of aluminum or magnesium powder and an oxidizing agent. It is used as an igniter for thermite. It is a substitute for the magnesium powder—barium peroxide igniter. This subigniter requires use of additional igniter mixture for initiation as it cannot be directly ignited by a fuse cord.

Comments: This material was tested. It is effective.

Caution: Do not attempt to ignite thermite subigniter without a time delay fuse as it burns very fast and hot and may endanger the user.

Reference: TM 31-201-1, Unconventional Warfare Devices and Techniques, para 0211.

MATCH HEAD IGNITER 01-11

Description: This igniter consists of match heads prepared by breaking the heads off match sticks and grouping them together to form an igniter. It is used to ignite incendiaries and readily flammable material such as rags, dry paper, dry hay, or the combustible vapor area above liquid fuels. It can be initiated by a match flame, fuse cord, or concentrated sulfuric acid.

Comments: This material was tested. It is effective.

Reference: TM 31-201-1, Unconventional Warfare Devices and Techniques, para 0205.

POTASSIUM PERMANGANATE—GLYCERIN IGNITER 01-12

Description: This igniter consists of a small pile of potassium permanganate crystals that are ignited by the chemical action of glycerin on the crystals. It is used to ignite incendiaries and readily flammable material such as rags, dry paper, dry hay, or the combustible vapor area above liquid fuels. Ignition is accomplished by causing a few drops of glycerin to contact the potassium permanganate crystals.

Comments: This material was tested. It is effective but is not reliable below 50° F.

Reference: TM 31-201-1, Unconventional Warfare Devices and Techniques, para 0206.

POWDERED ALUMINUM—SULFUR PELLETS IGNITER 01-13

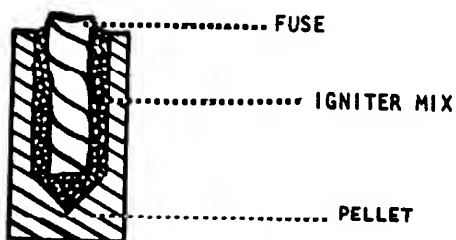

Description: This igniter consists of powdered aluminum, sulfur, and starch that are mixed together and shaped into pellets. It is used to ignite incendiaries and readily flammable materials such as rags, dry paper, dry hay, or the combustible vapor above liquid fuels. The pellets can be initiated by a fuse cord when used in combination with other igniter mixes.

Comments: This material was tested. It is effective.

Reference: TM 31-201-1, Unconventional Warfare Devices and Techniques, para 0207.

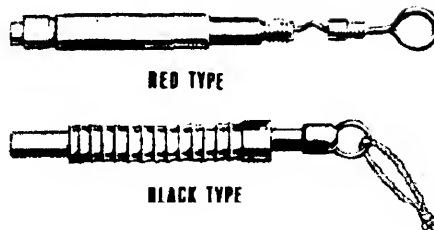

Description: These igniters were designed to ignite safety fuse but have also been used with a detonator to ignite trip-wire booby traps. There are two varieties; a red type and a black type, that differ only in exterior construction. When the sanded end of the pull string is drawn through the igniter composition, it ignites and flashes through the igniter body.

Comments: The test history of these items is unknown. They appear to be workable.

Reference: TM 9-1985-4, Japanese Explosive Ordnance, page 248.

CONCENTRATED SULFURIC ACID (OIL OF VITRIOL)

01-15

Description: This material is a heavy, corrosive, oily, colorless liquid of 93% concentration and 1.835 specific gravity, commonly known as concentrated sulfuric acid. This acid chars wood, cotton, and vegetable fibers, usually without causing fire. Heat is generated by the addition of water and depending on the quantities of acid and water and the rate of addition of water, an explosion or fire may occur. The primary use of concentrated sulfuric acid as an initiator is in combination with delay mechanisms wherein the acid is held out of contact with the igniter until it erodes a barrier. Concentrated sulfuric acid is commercially available in carboy containers but smaller amounts may be obtained from chemical laboratory supplies. It is recommended that small quantities, about one pint, be stored in glass containers until used. Battery grade acid (1.200 specific gravity) can be made into concentrated acid by heating until dense white fumes are produced, after which it is cooled and stored in glass containers.

Comments: This material was tested. It is effective.

Caution: Do not accidentally add water to concentrated sulfuric acid, always add acid to water.

Reference: TM 31-201-1, Unconventional Warfare Devices and Techniques, para 0103.

WATER

01-16

Description: Water causes spontaneous initiation of certain igniter mixtures by chemical reaction between the igniter materials in the presence of water or by chemical reaction of the water with igniter materials. The primary use for water as an igniter is in combination with delay mechanisms. It is initially held away from igniter material by a container that is eventually dissolved or the water is spilled from the container on to igniter material, thus initiating combustion.

Comments: This material was tested. It is effective. Water cannot be used at freezing temperatures but sulfuric acid of any concentration can be substituted for water in the initiation of water-activated igniters.

Reference: TM 31-201-1, Unconventional Warfare Devices and Techniques, para 0104.

NO-FLASH FUSE IGNITER

01-17

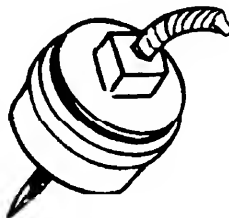

Description: A no-flash igniter can be constructed from $\frac{1}{4}$ inch standard pipe fittings. Other materials used include fuse cord, a flat head nail, strike-anywhere matches, and adhesive tape. A drill is required for cutting holes in the pipe fittings. The match heads are broken off and placed inside the pipe cap and the pipe plug is screwed into the cap. Fuse cord is pushed into the pipe plug and fastened with adhesive tape (not shown in the sketch). The flat head nail protrudes from the pipe cap and acts as a hammer for igniting the matches when the nail is struck against a hard surface. The burning matches cause the fuse to ignite. No flash is visible as the ignition process takes place internally.

Comments: This item was tested. It is effective.

Reference: TM 31-210, Improvised Munitions, sec VI, No. 5.

Section 02. INCENDIARIES

NAPALM INCENDIARY

02-1

Description: This incendiary consists of a liquid fuel which is gelled by the addition of soap powder or chips. It can be initiated by means of ignition delay systems or directly by a match flame. This incendiary is adhesive, long burning, and is suitable for setting fire to wooden and other combustible targets.

Comments: This material was tested. It is effective.

Reference: TM 31-201-1, Unconventional Warfare Devices and Techniques, para 0301.

PARAFFIN—SAWDUST INCENDIARY

02-2

Description: This incendiary consists of a mixture of paraffin wax and sawdust. It can be initiated by means of ignition delay systems or directly by a match flame. It is used for setting fire to wooden and other combustible materials. Beeswax may be substituted for paraffin wax if desired. This incendiary is slow starting but a few minutes after initiation, vigorous burning occurs.

Comments: This materials was tested. It is effective.

Reference: TM 31-201-1, Unconventional Warfare Devices and Techniques, para 0304.

GELLED GASOLINE INCENDIARY (EXOTIC THICKENERS)

02-3

Description: This item consists of gasoline that is gelled by the addition of organic chemicals. It can be initiated by means of ignition delay systems or directly by a match flame. This incendiary is adhesive and long burning and is suitable for setting fire to wooden and other combustible targets. The following gasoline gelling systems were used. Numbers in parentheses are grams added per gallon of gasoline. The first ingredient is stirred into the gasoline at room temperature. When the second is added, the gasoline will gell within a few minutes.

<i>System</i>	<i>Ingredients</i>
1	Lauryl amine (55), toluene diisocyanate (27)
2	Coco amine (55), toluene diisocyanate (27)
3	Lauryl amine (57), hexamethylene diisocyanate (25)
4	Oleyl amine (59), hexamethylene diisocyanate (23)
5	t-Octyl amine (51), toluene diisocyanate (31)
6	Coco amine (51), naphthyl isocyanate (31)
7	Delta-aminobutylmethyldiethoxysilane (51), Hexamethylene diisocyanate (31)

Comments: These thickeners were tested. They are effective.

Caution: All of the ingredients listed are corrosive to the skin. In case of contact, wash with detergent and water.

Reference: TM 31-201-1, Unconventional Warfare Devices and Techniques, para 0302.

FLAMMABLE LIQUIDS INCENDIARY

02-4

Description: Flammable liquids such as gasoline, kerosene, turpentine, etc. are excellent for starting fires with easily combustible materials. They can be ignited by a match and burn with a hot flame. These liquids are readily available and relatively safe to carry and transport. No preparation is required other than placing the liquid in an air-tight container.

Comments: These materials were tested. They are effective.

Reference: TM 31-201-1, Unconventional Warfare Devices and Techniques, para 0308.

FIRE BOTTLE INCENDIARY (IMPACT IGNITION)

02-5

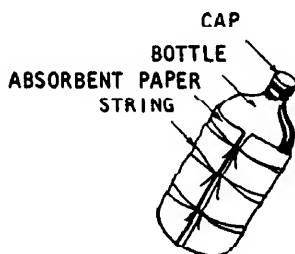

Description: This item consists of a glass bottle containing gasoline and concentrated sulfuric acid. The outside of the bottle is wrapped with a rag or absorbent paper that is soaked with a solution of granulated sugar and potassium chlorate just prior to use. When thrown with sufficient force against a hard surface, the bottle will break and the sugar - potassium chlorate will react with the sulfuric acid causing the gasoline to ignite and engulf the target in flames.

Comments: This item was tested. It is effective.

References: TM 31-201-1, Unconventional Warfare Devices and Techniques, para 0305.

TM 31-210, Improvised Munitions, sec V, No. 1.

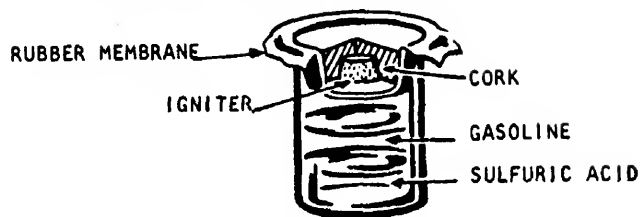

Description: This item consists of a bottle containing gasoline and concentrated sulfuric acid that is ignited by the reaction of the acid with sugar-chlorate igniter. A rubber membrane acts as an ignition delay by preventing the acid from contacting the sugar-chlorate until the acid eats through the membrane. The device is prepared with the bottle in the upright position. Erosion of the membrane is accomplished by inverting the bottle thereby allowing the acid, that is heavier than the gasoline, to contact the membrane and begin its erosive action. This incendiary works well on readily ignitable materials.

Comments: This item was tested. It is effective.

Reference: TM 31-201-1, Unconventional Warfare Devices and Techniques, para 0306.

GELLED FLAME FUELS—LATEX SYSTEMS

02-7

Description: Commercial rubber latex or natural latex (obtained from certain trees and plants) can be used in combination with acetic acid, sulfuric acid, hydrochloric acid or with suitable acid salts to gel gasoline for use as a flame fuel. In the commercial method, the latex is added to the gasoline and thoroughly mixed. Acetic acid or other acid is added to the gasoline mix and the mixture agitated until thickening occurs. In the natural method, the gasoline is added to the latex in a container. The container is covered and the mixture allowed to stand until it gels.

Comments: This technique was tested. It is effective.

References: TM 31-210, Improvised Munitions, sec V, No. 4.5.

TM 31-201-1, Unconventional Warfare Devices and Techniques, para 0303.

GELLED FLAME FUELS—WAX SYSTEM

02-8

Description: Any of several common waxes can be used to gel gasoline for use as a flame fuel that will adhere to target surfaces. Either natural wax, obtained from plants and berries, or commercially manufactured waxes can be used to prepare the gelled fuel. The wax is first melted and

poured into a jar or bottle that has been placed in a hot water bath. The gasoline is then added to the wax in the bottle. When the wax has dissolved in the gasoline, the water bath is allowed to cool. Additional wax may be required to form the gel or a small amount of lye in addition to the extra wax may be necessary.

Comments: This technique was tested. It is effective.

References: TM 31-210, Improvised Munitions, sec V, No. 4.6.
TM 31-201-1, Unconventional Warfare Devices and Techniques, para 0303.

GELLED FLAME FUELS—LYE SYSTEMS

02-9

Description: Lye can be used in combination with powdered rosin or castor oil to gel gasoline for use as a flame fuel that will adhere to target surfaces. The rosin or castor oil is added to the gasoline and the mixture is thoroughly stirred. In a separate container, the lye is slowly added to water while stirring. The lye solution is then added to the gasoline mix and the mixture is stirred until thickening occurs. The gelled fuel can be thinned by the addition of gasoline.

Comments: This technique was tested. It is effective.

Caution: Lye solution can burn the skin and damage clothing. If any is spilled, wash away immediately with large amounts of water.

References: TM 31-210, Improvised Munitions, sec V, No. 4.1.
TM 31-201-1, Unconventional Warfare Devices and Techniques, para 0303.

GELLED FLAME FUELS—LYE-ALCOHOL SYSTEMS

02-10

Description: Lye can be used in combination with alcohol and tallow or any of several fats to gel gasoline for use as a flame fuel. The tallow is added to the gasoline and stirred until dissolved; the alcohol is then added to the gasoline mixture. In a separate container, the lye is slowly added to water while stirring. The lye solution is poured into the gasoline mix and the mixture is stirred until thickening occurs. The gelled fuel can be thinned by the addition of gasoline.

Comments: This technique was tested. It is effective.

References: TM 31-210, Improvised Munitions, sec V, No. 4.2.
TM 31-201-1, Unconventional Warfare Devices and Techniques, para 0303.

GELLED FLAME FUELS—SOAP—ALCOHOL SYSTEMS

02-11

Description: Common household soap can be used in combination with alcohol to gel gasoline for use as a flame fuel that will adhere to target

surfaces. The alcohol and gasoline are mixed in a container and soap powder or flakes are added and stirred until thickening occurs.

Comments: This technique was tested. It is effective.

Reference: TM 31-210, Improvised Munitions, sec V, No. 4.3.

GELLED FLAME FUELS—EGG SYSTEMS **02-12**

Description: The white of any bird egg can be used in combination with salt, sugar, cocoa, or other additive to gel gasoline for use as a flame fuel that will adhere to target surfaces. The egg white and gasoline are mixed in a container and the salt or other additive stirred in until thickening occurs. Only egg white can be used in these systems. If egg yolk is mixed in with egg white, the egg should be discarded.

Comments: This technique was tested. It is effective.

References: TM 31-210, Improvised Munitions, sec V, No. 4.4.

TM 31-201-1, Unconventional Warfare Devices and Techniques, para 0303.

GELLED FLAME FUELS—ANIMAL BLOOD SYSTEMS **02-13**

Description: Animal blood can be used in combination with salt, sugar, or other additive to gel gasoline for use as a flame fuel that will adhere to target surfaces. The strained blood and gasoline are mixed in a container and the salt or other additive stirred in until thickening occurs.

Comments: This technique was tested. It is effective.

Caution: Infection may be caused if animal blood gets into an open wound.

Reference: TM 31-210, Improvised Munitions, sec V, No. 4.7.

TM 31-201-1, Unconventional Warfare Devices and Techniques, para 0303.

INCENDIARY BRICK **02-14**

Description: This item is composed of potassium chlorate (40 parts by volume), sulfur (15), sugar (20), iron filings (10), and wax (15). When properly made, it has the appearance of an ordinary building brick. It is used for setting fire to wood and other combustible materials. This incendiary can be initiated directly by igniters and in combination with ignition delay devices.

Comments: This item was tested. It is effective.

Reference: TM 31-201-1, Unconventional Warfare Devices and Techniques, para 0309.

THERMITE INCENDIARY

02-15

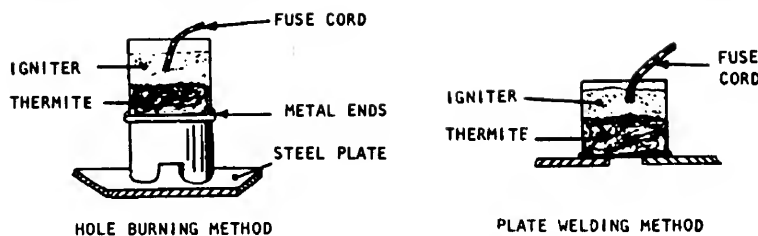

Description: Thermite is composed of iron oxide and aluminum powder. It may be obtained as a commercial material or be improvised by mixing these two ingredients (three parts iron oxide and two parts aluminum powder, by volume). Thermite requires high heat for initiation and specific igniters must be used. This incendiary is used to attack metal targets by applying localized heat. It causes holes to be burned through metal and to drip molten metal on interior components. It is also useful for welding together machinery parts or steel plates (see illustrations for set-up). Thermite is safe to handle and transport because of its high ignition temperature. It burns well in cold and windy weather.

Comments: This material was tested. It is effective.

Reference: TM 31-201-1, Unconventional Warfare Devices and Techniques, para 0307.

MECHANICALLY INITIATED FIRE BOTTLE

02-16



Description: This device consists of a glass jar or bottle containing gasoline, and a metal can that will fit snugly over the top of the jar. A coil spring, with four matches, attached is positioned inside the can. The spring is compressed and held in place by a flat stick or metal strip that acts as a safety to prevent ignition if the fire bottle should be

accidentally broken. The can is placed on the top of the jar and secured with cord and tape. The safety stick is carefully removed and the device thrown against a hard surface to break the jar and spill the gasoline on the target. When the jar is broken the spring inside the can is released and the matches are scraped against the can and ignite. The matches then ignite the gasoline.

Comments: This item was tested. It is effective.

Reference: TM 31-210, Improvised Munitions, sec V, No. 3.

JAPANESE INCENDIARY BRICK

02-17

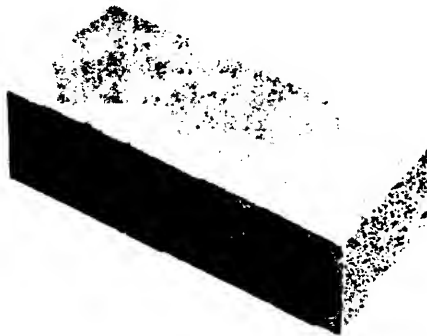

Description: This incendiary is a skillful imitation of a standard, glazed building brick to which it is comparable in size, weight, and appearance. The brick is wax coated with paint to give it a realistic finish and to allow it to be carried about without detection. There is no pocket for insertion of an igniter. The brick is composed of potassium chlorate, sulfur, ground coal or sugar, iron filings, wax, and a red coloring matter.

Comments: The test history of this item is not known. The item appears to be effective.

References: (C) FSTC 381-5012, Typical Foreign Unconventional Warfare Weapons (U), Army Materiel Command, Sep. 1964, page 46.

TM 9-1985-4, Japanese Explosive Ordnance, page 262.



Description: This incendiary resembles a bar of *Ivory* soap. The word *Ivory* is stamped on one side and *Proctor & Gamble* on the other. This soap incendiary is difficult to ignite but burns with an intense flame. It can be easily extinguished with water. No method of ignition was found with this device but some type of ignition device was probably inserted into the recess in the side of the bar. The bar is composed of barium nitrate, paraffin, magnesium, aluminum, rosin, ferrosferic oxide, nitrocellulose, and gritty siliceous material.

Comments: The test history of this item is not known. The item appears to be effective.

References: (C) FSTC 381-5012, Typical Foreign Unconventional Warfare Weapons (U), Army Materiel Command, Sep 1964, page 50.
TM 9-1985-4, Japanese Explosive Ordnance, page 263.

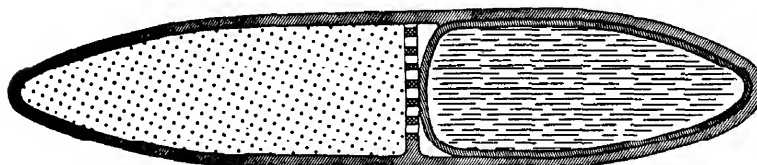

Description: This incendiary cigar consists of a lead casing containing a glass ampoule of sulfuric acid (right), a cardboard barrier, and a mixture of potassium chlorate and sugar (left). A strong squeeze by the fingers on the blunt end of the casing breaks the ampoule from which the acid leaks to contact the barrier. Eventually the acid eats through the barrier into the potassium chlorate and sugar mixture causing ignition. This item is generally used against easily combustible materials.

Comments: The test history of this item is not known. The device is presumed to be effective.

Reference: (C) FSTC 381-5012, Typical Foreign Unconventional Warfare Weapons (U), Army Materiel Command, Sep 1964, page 44.

GERMAN INCENDIARY PEN AND PENCIL

02-20

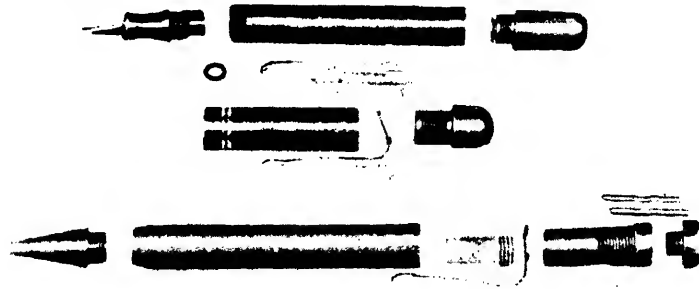

Description: This pen and pencil set together houses a time delay incendiary train. A glass ampoule of acid, a celluloid disk, and a plunger for crushing the ampoule are housed in the body of the pen. The potassium chlorate and sugar mixture are housed in the pencil. The device is prepared for use by removing and discarding the pencil point and the pen cap. The pen body is then screwed into the pencil body, and the plunger mechanism is screwed into the hole formerly occupied by the pencil point. Twisting the upper end of the pen body causes the plunger to crush the glass ampoule. The sulfuric acid then begins to react with the celluloid disk. When the acid penetrates the disk, it drips down through the nib of the pen and onto the mixture of potassium chlorate and sugar causing ignition.

Comments: The test history of this item is not known. The device is presumed to be effective. It would be difficult to improvise this manufactured device because of the small available space.

Reference: (C) FSTC 381-5012, Typical Foreign Unconventional Warfare Weapons (U), Army Materiel Command, Sep 1964, page 43.

GERMAN INCENDIARY PEN

02-21



Description: This pen conceals an incendiary device. It consists of a magnesium casing containing a cocked striker, a primer pellet, a delay element, an igniting charge, and a quantity of thermit. When the barrel of the pen is rotated 180°, the striker spring drives a striker into the primer, igniting the delay element, the igniting charge, and finally the thermit.

Comments: The test history of this item is not known. The device is presumed to be effective. It would be difficult to improvise this manufactured device because of the small available space.

Reference: (C) FSTC 381-5012, Typical Foreign Unconventional Warfare Weapons (U), Army Materiel Command, Sep 1964, page 44.

GERMAN INCENDIARY CAPSULE

02-22

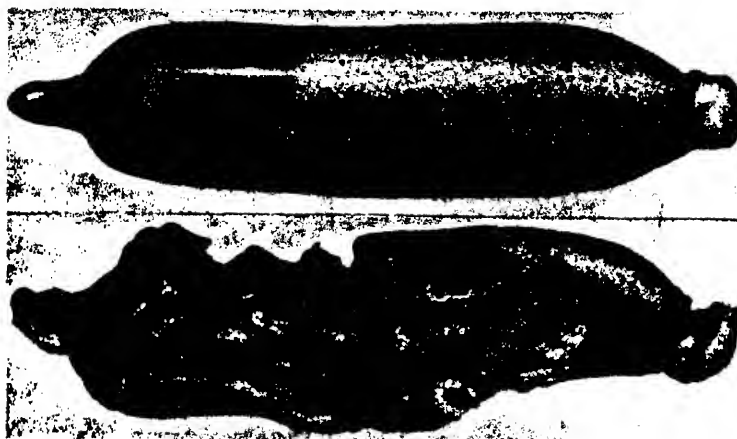

Description: The German incendiary capsule is a nondisguised factory made item. The capsule is approximately 5 inches long by 1¼ inches in diameter. It consists of a flammable casing filled with a mixture of gasoline and paraffin. One end of the casing has been coated with a match head composition so that it may be ignited by striking it on a safety-match box. The illustration shows an unburned and a burned capsule.

Comments: The test history of this item is not known. The device is presumed to be effective.

Reference: (C) FSTC 381-5012, Typical Foreign Unconventional Warfare Weapons (U), Army Materiel Command, Sep 1964, pages 47 and 48.

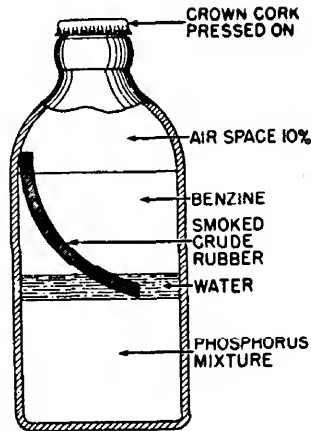

Description: The British incendiary hand or rifle grenade No. 76, MK 1 is now obsolete. It is designed to be thrown against armored vehicles to produce an incendiary and smoke effect. It consists of a short-necked bottle containing benzene, crude rubber, white phosphorus, and water. When the bottle is broken, the phosphorus ignites on contact with air, which ignites the benzene and rubber.

Comments: The test history of this item is not known. The item is presumed to be effective. The grenade should not be shaken before throwing, as agitation causes the formation of an emulsion in which the droplets of phosphorus are protected from the air by a covering of water.

Reference: (C) TM 9-1985-1, British Explosive Ordnance (U), page 395.

JAPANESE INCENDIARY CYLINDERS

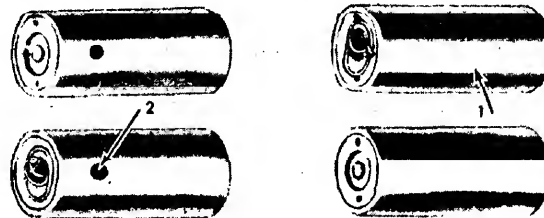

Description: This device is a light metal cylinder filled with thermit. An igniter is located in the center of the top section. Four types have been found, differing in casing and igniter materials. One casing is a

plain cylinder (1), while the other type has vents (2) around the top to allow more rapid escape of the thermite. Both casings can be fitted with either a friction pull igniter or a scratch-type igniter.

These igniters employ a delay element and a 5 gm first-fire charge of antimony sulphide, aluminum, and potassium chlorate. A circular piece of wood with rough sides is provided as a scratch block for the scratch type igniter. The block is wrapped in waxed paper and taped to the top of the cylinder in which it is used. After the igniter is initiated and the delay time has expired, the first-fire charge and the main incendiary charge are ignited in turn.

Comments: The test history of these items is not known. They appear to be effective.

Reference: TM 9-1985-4 Japanese Explosive Ordnance, page 261.

JAPANESE INCENDIARY BOTTLE

02-25

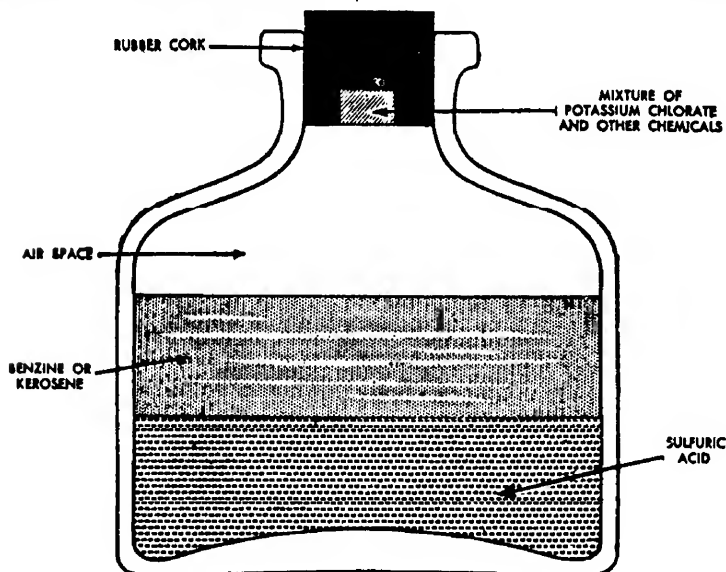

Description: This bottle is an incendiary device. Chemicals are concealed in its cork and the bottle is filled with flammable liquids. When the bottle is shaken or when it is tipped over, the reaction between the chemical in the cork and the sulfuric acid causes the bottle to burst and the benzine or other flammable liquid to ignite.

Comments: The test history of this item is not known. The device is presumed to be effective.

Reference: FM 5-31, Boobytraps.

VIET CONG IMPROVISED GRENADE



Description: This spherical-shaped grenade is used to set fire to flammable material. It is made of two hemispherical shaped pieces of metal welded together. It is 1½ inches in diameter and weighs 1½ ounces. Two small holes in the grenade are sealed with a piece of light paper. One third of the grenade case is filled with sodium. This substance will burn and smoke upon contact with water. A coat of wax and the pieces of paper are removed before use. When thrown into water, the grenade will send out flames and smoke for 4 or 5 seconds. Despite the burning, the incendiary grenade case remains intact and emits a smell similar to that of kerosene. If touched, it feels as if it were covered with a coat of soap.

Comments: The test history of this item is not known. The device appears to be effective.

Reference: Report EODS-65-3, Viet Cong's Explosive Ordnance Used in South Vietnam, U. S. Naval School, Explosive Ordnance Disposal, Jul 1965, page 34.

Section 03. DELAY MECHANISMS

CIGARETTE DELAY (FUSE CORD)

03-1

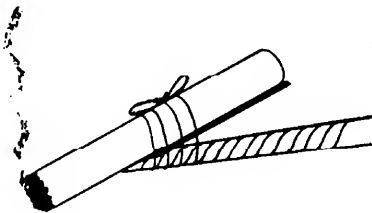

Description: A simple time delay can be made from a cigarette, paper match, fuse cord, and a piece of string. The fuse cord is first cut to expose the inner core. The cigarette is then lighted. A paper match is placed with the head over the exposed end of the fuse cord, and the match and fuse cord are tied to the burning cigarette with the string. The burning cigarette is suspended by the fuse so that it burns freely.

Comments: This item was tested. It is effective. A test should be made under prevailing atmospheric conditions to determine accurate delay time.

Reference: TM 31-210, Improvised Munitions, sec VI, No. 3.

ACID DELAY INCENDIARY

03-2

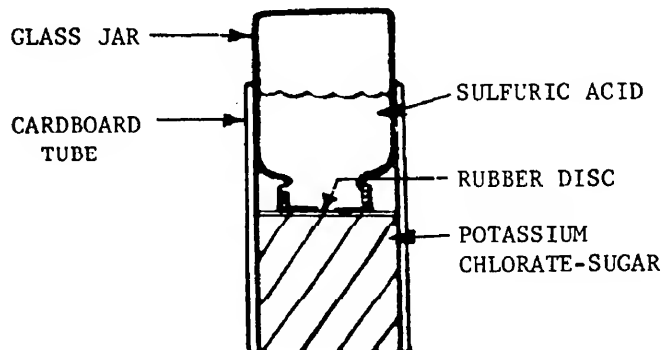

Description: This device works by the action of concentrated sulfuric acid on a rubber disk that acts as a barrier between the acid and potassium chlorate-sugar igniter. A small jar containing the sulfuric acid is inverted and slipped into a tubular container of potassium chlorate-sugar that had been previously prepared. A hole in the lid of the jar is covered by a rubber disk placed inside the lid. After a time delay depending on the thickness and type of rubber used, the acid will eat through the disk and ignite the sugar-chlorate mix that in turn ignites the incendiary materials.

Comments: This device was tested. It is workable.

Caution: Sulfuric acid can burn the skin and damage clothing. If any is spilled, wash away immediately with large amounts of water.

Reference: TM 31-210, Improvised Munitions, sec V, No. 5.

CIGARETTE DELAY

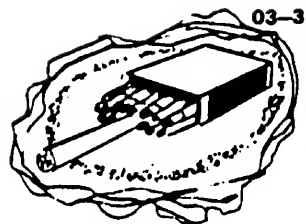
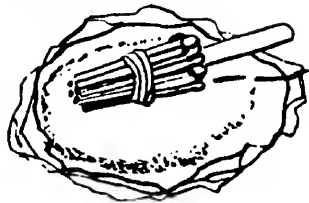

PICKET FUSE DELAY

Description: This item consists of a bundle of matches wrapped around a cigarette. Ignition occurs when the burning end of the cigarette reaches the match heads. It can be used directly on easily ignited materials or as a delay mechanism for initiation of igniters. To prepare this delay, a wooden match head is pushed into a cigarette a predetermined distance to obtain the approximate delay time. The remaining matches are bundled around the cigarette with the match heads at the same location as the match in the cigarette. The cigarette should be placed so that the flame travels horizontally or upward. A burning cigarette should not be held or clamped in position as it will not burn past the point of confinement.

Comments: This technique was tested. It is workable.

Reference: TM 31-201-1, Unconventional Warfare Devices and Techniques, para 0401.

MATCH BOX DELAY

GELATIN CAPSULE DELAYS

03-4

WATER OR ACID
IN CAPSULE

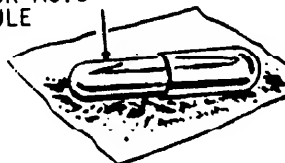

Description: Gelatin capsule delays work by the action of either water or concentrated sulfuric acid on the gelatin, depending on the type of igniter materials used. When the gelatin is dissolved, the liquid comes into contact and reacts with the igniter mix. These delays can be used with various igniters; however, delay time varies with temperature level and they will not work below 32° F.

Comments: These items were tested. They are effective.

Reference: TM 31-201-1, Unconventional Warfare Devices and Techniques, para 0402.

RUBBER MEMBRANE DELAY

03-5

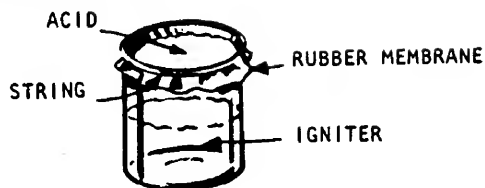

Description: This delay works by the action of concentrated sulfuric acid on a rubber membrane that acts as a barrier between the acid and an igniter mix. When the acid eats through the membrane, it drips onto the igniter mix and combustion occurs. The delay is not reliable below 40° F. Delay time fluctuates with change in temperature.

Comments: This item was tested. It is workable.

Reference: TM 31-201-1, Unconventional Warfare Devices and Techniques, para 0403.

PAPER DIAPHRAGM DELAY (SULFURIC ACID)

03-6

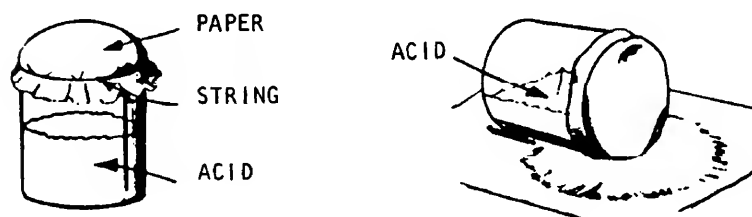

Description: This delay consists of a half-full jar of concentrated sulfuric acid and a paper diaphragm. The paper diaphragm is securely tied over the mouth of the jar. When the jar is laid on its side, the acid soaks through and contacts igniter material causing combustion. The time delay depends on the thickness of paper. This device is not reliable below 40° F.

Comments: This item was tested. It is effective.

Reference: TM 31-201-1, Unconventional Warfare Devices and Techniques, para 0404.

PAPER DIAPHRAGM DELAY (GLYCERIN)

03-7



Description: This delay consists of potassium permanganate crystals wrapped in layers of absorbent paper. Glycerin is brought into contact with the potassium permanganate by soaking through the paper wrapping. Combustion occurs when the glycerin contacts the crystals. The time delay depends on the thickness of paper. This delay can be used for directly igniting incendiaries but it is not recommended for use at temperatures below 50° F.

Comments: This item was tested. It is workable.

Reference: TM 31-201-1, Unconventional Warfare Devices and Techniques, para 0405.

CANDLE DELAY

03-8

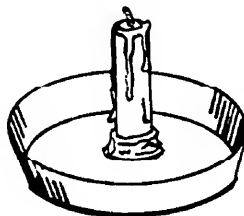

Description: This delay consists of a lighted candle inserted in a container of liquid fuel such as fuel oil or kerosene. Ignition of the liquid occurs when the flame burns down to the liquid level. This device is used to ignite incendiary materials such as rags or paper. It works well in hot or cold weather but shielding is required in areas of strong winds or drafts. This delay is not recommended for use with highly volatile liquids as premature ignition may take place.

Comments: This item was tested. It is workable.

Reference: TM 31-201-1, Unconventional Warfare Devices and Techniques, para 0406.

OVERFLOW DELAY

03-9

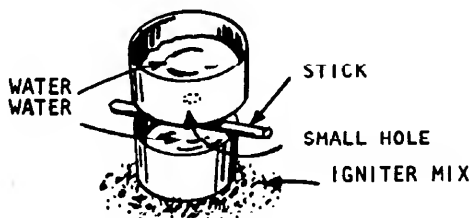

Description: This delay consists of two tin cans, one atop the other, that contain water or glycerin. A small hole is punched through the bottom of the upper can to permit the liquid to drip into the lower can. When

the lower can fills and overflows, the liquid will react with the igniter material placed around the lower can and combustion occurs. This delay is used for initiating water or glycerin activated igniters. Glycerin flows slowly when cold and water cannot be used at or below freezing temperatures.

Comments: This item was tested. It is workable.

Reference: TM 31-201-1, Unconventional Warfare Devices and Techniques, para 0407.

TIPPING DELAY

03-10

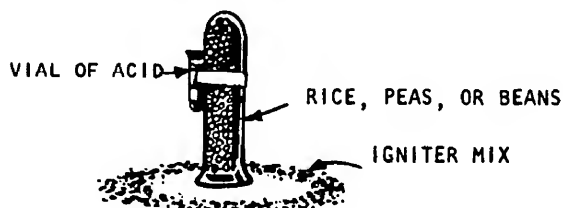

Description: This device consists of a container filled with wet beans, rice, or peas. The container is inverted and placed inside a ring of igniter materials and a smaller container of water or acid is attached to the inverted container. As the beans expand, the container is caused to topple and the acid or water is spilled onto the igniter and combustion occurs. This delay is used for initiating water or acid activated igniters. It should not be used at or below freezing temperature.

Comments: This item was tested. It is workable.

Reference: TM 31-201-1, Unconventional Warfare Devices and Techniques, para 0408.

TIPPING DELAY—CORROSIVE OR DISSOLVING ACTION

03-11



**DISSOLVING
TIPPING DELAY**

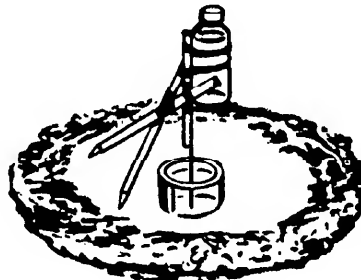

**CORROSIVE
TIPPING DELAY**

Description: This device consists of a bottle, containing water, glycerin, or concentrated sulfuric acid, supported by an improvised tripod. One leg of the tripod is made of material that decomposes when set in a dissolving or corrosive liquid. When the leg is dissolved, the bottle topples over spilling its contents onto igniter material, and combustion occurs. This delay is used for initiating water, glycerin, or acid activated igniters.

Comments: This device was tested. It is workable. Do not use water below freezing temperatures.

Reference: TM 31-201-1, Unconventional Warfare Devices and Techniques, para 0409.

BALANCING STICK DELAY

03-12

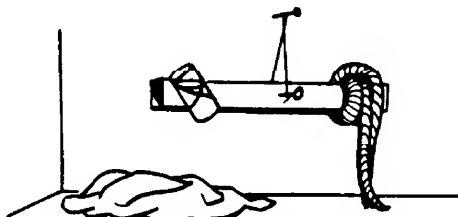

Description: This device consists of a wooden stick, a small vial, a nail, string, and a piece of cloth. A hole is drilled through the middle of the stick and the vial is fastened to one end and the piece of cloth to the other. The cloth is positioned so that the stick balances on a nail, passing through the hole in the stick, when the vial is approximately $\frac{3}{4}$ full of initiating liquid. Solvent is used to wet the cloth and make it heavy and liquid is added to the vial to maintain balance. As the solvent evaporates, the stick rotates and the liquid is spilled onto an igniter mix and combustion takes place. This delay is used for initiating water, glycerin, and acid activated igniters.

Comments: This device was tested. It is workable. Do not use water as an initiating agent below freezing temperatures.

Reference: TM 31-201-1, Unconventional Warfare Devices and Techniques, para 0410.

RUBBER BAND DELAY

03-13

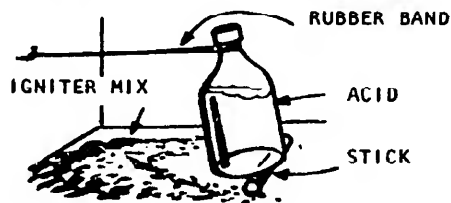

Description: This device consists of a rubber band that is soaked in gasoline or carbon disulfide until it becomes stretched. Upon removal from the solvent, one end of the rubber band is attached to a wall and the other end looped around the neck of a bottle containing igniter fluid. The rubber band contracts as the solvent evaporates causing the bottle to tip over and spill its contents on igniter materials. This delay is used to initiate water, glycerin, or acid activated igniters.

Comments: This device was tested. It is workable. Do not use water below freezing temperatures.

Reference: TM 31-201-1, Unconventional Warfare Devices and Techniques, para 0411.

ALARM CLOCK DELAY

03-14

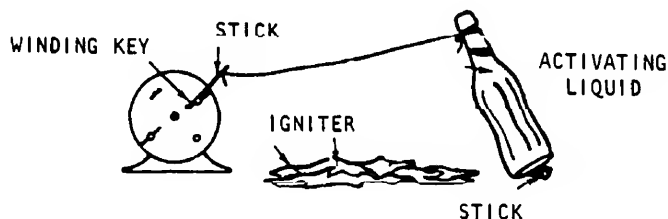

Description: This device employs a manually wound alarm clock for igniting materials after a definite delay time. The alarm bell is removed and a string is fastened to the key used for winding the alarm. The other end of the string is attached to a bottle containing initiating liquid. When the alarm mechanism is activated, the winding key reels in the string causing the bottle to tip over and spill the liquid onto igniter materials. This delay is used for initiating water, glycerin, or acid activated igniters.

Comments: This device was tested. It is workable. Do not use water below freezing temperatures.

Reference: TM 31-201-1, Unconventional Warfare Devices and Techniques, para 0412.

Section 04. SPONTANEOUS COMBUSTION

BOILED LINSEED OIL—COBALT DRIER—LEAD DRIER— COMBUSTIBLE MATERIAL

04-1

Description: Combinations of boiled linseed oil, driers, and combustible materials were evaluated as devices for spontaneous combustion. Combustible materials consist of such items as cotton waste or batting, sawdust, and kapok. Spontaneous combustion is the outbreak of fire in

combustible materials that occurs without application of direct flame or spark. The oil and driers are mixed and this combination is soaked into combustible materials located in a suitable container. Heat produced by the chemical action of the driers in the oil is transferred to the confined combustible material with resultant outbreak of fire. These devices operate with a natural delay caused by the chemical reaction time of the drying process in the oil. The various combinations tested are summarized in the table. In each case the linseed oil was mixed with $\frac{1}{2}$ teaspoon of cobalt drier and 2 teaspoons of lead drier. The quantities shown for each system are approximately correct for use in a 1 gallon container.

<i>System number</i>	<i>Quantity of boiled linseed oil</i>	<i>Combustible material (tightly packed)</i>
1	$\frac{1}{3}$ pint	cotton waste, 1 pint
2	$\frac{1}{3}$ pint	cotton batting, 1 pint
3	$\frac{1}{3}$ pint	sawdust, 1 pint
4	$\frac{1}{3}$ pint	kapok, 1 pint

Comments: The mixtures were tested. They were effective. The impregnated material should fill the container to approximately $\frac{1}{3}$ to $\frac{1}{2}$ the volume for best results. As approximately 70° F., delay time to ignition is roughly 1 to 2 hours. With Fire Fudge or Fuse Cord added to the impregnated combustible material, delay time is reduced to roughly $\frac{1}{2}$ to 1 hour. Vegetable oil and drier can be mixed and stored in an air-tight container for 1 week before use. Longer storage is not recommended.

Reference: TM 31-201-1, Unconventional Warfare Devices and Techniques, para 0501.

RAW LINSEED OIL—COBALT DRIER—LEAD DRIER— 04-2 COMBUSTIBLE MATERIAL

Description: Combinations of raw linseed oil, driers, and combustible materials were evaluated as devices for spontaneous combustion. Combustible materials consist of such items as cotton waste or batting, sawdust, and kapok. Spontaneous combustion is the outbreak of fire in combustible materials that occurs without application of direct flame or spark. The oil and driers are mixed and this combination is soaked into combustible material located in a suitable container. Heat produced by the chemical action of the driers in the oil is transferred to the confined combustible material with resultant outbreak of fire. These devices operate with a natural delay caused by the chemical reaction time of the drying process in the oil. Raw linseed oil, $\frac{1}{3}$ pint, was mixed with $\frac{1}{2}$ teaspoon cobalt drier and 2 teaspoons lead drier and poured on 1 pint tightly packed kapok. These quantities are approximately correct for use in a 1 gallon container.

Comments: The mixture was tested. It was effective. The impregnated material should fill the container to approximately $\frac{1}{3}$ to $\frac{1}{2}$ the volume for best results. At approximately 70° F., delay time to ignition is roughly 1 to 2 hours. With Fire Fudge or Fuse Cord added to the impregnated combustible material, delay time is reduced to roughly $\frac{1}{2}$ to 1 hour. Vegetable oil and drier can be mixed and stored in an airtight container for 1 week before use. Longer storage is not recommended.

Reference: TM 31-201-1, Unconventional Warfare Devices and Techniques, para 0501.

**SAFFLOWER OIL—COBALT DRIER—LEAD DRIER— 04-3
COMBUSTIBLE MATERIAL**

Description: Combinations of safflower oil, driers, and combustible materials were evaluated as devices for spontaneous combustion. Combustible materials consist of such items as cotton waste or batting, sawdust, and kapok. Spontaneous combustion is the outbreak of fire in combustible materials that occurs without application of direct flame or spark. The oil and driers are mixed and this combination is soaked into combustible material located in a suitable container. Heat produced by the chemical action of the driers in the oil is transferred to the confined combustible material with resultant outbreak of fire. These devices operate with a natural delay caused by the chemical reaction time of the drying process in the oil. The various combinations tested are summarized in the table. In each case the safflower oil was mixed with $\frac{1}{2}$ teaspoon of cobalt dryer and 2 teaspoons of lead drier. The quantities shown for each system are approximately correct for use in a 1 gallon container.

<i>System number</i>	<i>Quantity of safflower oil</i>	<i>Combustible material (tightly packed)</i>
1	$\frac{1}{8}$ pint	cotton waste, 1 pint
2	$\frac{1}{8}$ pint	cotton batting, 3 pints
3	$\frac{1}{3}$ pint	sawdust, 1 pint
4	$\frac{1}{3}$ pint	kapok, 1 pint

Comments: The mixtures were tested. They were effective. The impregnated material should fill the container to approximately $\frac{1}{3}$ to $\frac{1}{2}$ the volume for best results. At approximately 70° F., delay time to ignition is roughly 1 to 2 hours. The exception to this is system 4 where delay time to ignition is about 2 to 3 hours. With Fire Fudge or Fuse Cord added to the impregnated combustible material, delay time is reduced to roughly $\frac{1}{2}$ to 1 hour. Vegetable oil and drier can be mixed and stored in an airtight container for 1 week before use. Longer storage is not recommended.

Reference: TM 31-201-1, Unconventional Warfare Devices and Techniques, para 0501.

**TUNG OIL—COBALT DRIER—LEAD DRIER—
COMBUSTIBLE MATERIAL**

04-4

Description: Combinations of tung oil, driers, and combustible materials were evaluated as devices for spontaneous combustion. Combustible materials consist of such items as cotton waste or batting, sawdust, and kapok. Spontaneous combustion is the outbreak of fire in combustible materials that occurs without application of direct flame or spark. The oil and driers are mixed and this combination is soaked into combustible material located in a suitable container. Heat produced by the chemical action of the driers in the oil is transferred to the confined combustible material with resultant outbreak of fire. These devices operate with a natural delay caused by the chemical reaction time of the drying process in the oil. The various combinations tested are summarized in the table. In each case the tung oil was mixed with $\frac{1}{2}$ teaspoon of cobalt drier and 2 teaspoons of lead drier. The quantities shown for each system are approximately correct for use in a 1 gallon container.

<i>System number</i>	<i>Quantity of tung oil</i>	<i>Combustible material (tightly packed)</i>
1	$\frac{1}{3}$ pint	cotton waste, 1 pint
2	$\frac{1}{3}$ pint	cotton batting, 3 pints
3	$\frac{1}{3}$ pint	sawdust, 1 pint
4	$\frac{1}{3}$ pint	kapok, 1 pint

Comments: The mixtures were tested. They were effective. The impregnated material should fill the container to approximately $\frac{1}{3}$ to $\frac{1}{2}$ the volume for best results. At approximately 70° F., delay time to ignition is roughly 1 to 2 hours. With Fire Fudge or Fuse Cord added to the impregnated combustible material, delay time is reduced to roughly $\frac{1}{2}$ to 1 hour. Vegetable oil and drier can be mixed and stored in an air-tight container for 1 week before use. Longer storage is not recommended.

Reference: TM 31-201-1, Unconventional Warfare Devices and Techniques, para 0501.

CHAPTER 10. EXPLOSIVES

Section 11. INITIATORS

ELECTRIC BULB INITIATOR

11-1

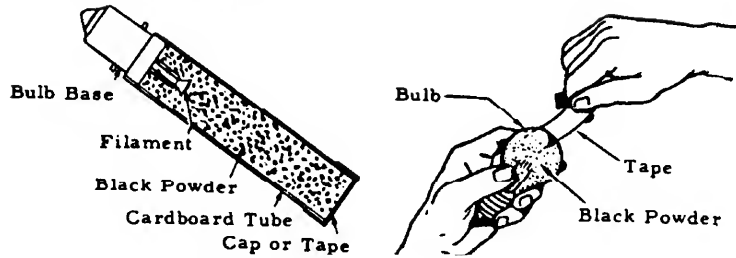

CARDBOARD TUBE DEVICE

FILLED BULB DEVICE

Description: This device is an electric initiator made from a flashlight bulb or an automobile light bulb. The cardboard tube device, shown above, is constructed by first breaking away the glass of the bulb, being careful not to damage the filament. A tube, prepared by rolling and taping a strip of cardboard, is then slipped over and attached to the base of the bulb. Black powder is poured into the tube and the open end closed with tape. The filled bulb device is constructed by filing a small hole in the top of the bulb, pouring in black powder to fill the bulb and taping over to seal the hole. In both devices, when an electric current is applied, the hot filament ignites the black powder.

Comments: These devices were tested. They are workable.

Reference: TM 31-210, Improvised Munitions, sec vi, No. 1.

CONCUSSION DETONATOR, M1

11-2

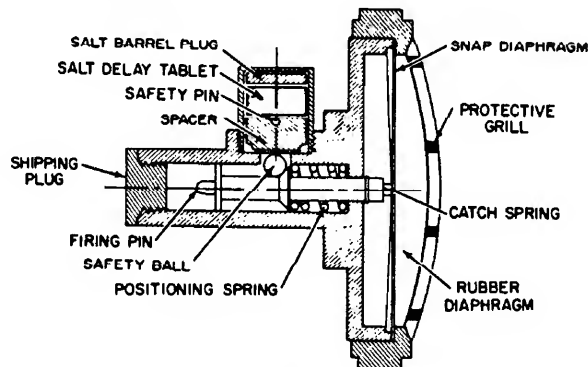

Description: This detonator is a mechanical firing device that is actuated by the concussion wave of a blast. It can be used to fire several charges simultaneously without interconnecting the charges with wires or detonating cord. A single charge fired in water or air will detonate all charges equipped with concussion detonators within range of the main charge or each other. For safety, while arming the device in water, water-soluble time-delay tablets are supplied with the device.

Comments: This device was tested. It is effective.

Reference: FM 5-25, Explosives and Demolitions, page 31.

ELECTRIC DETONATOR

11-3

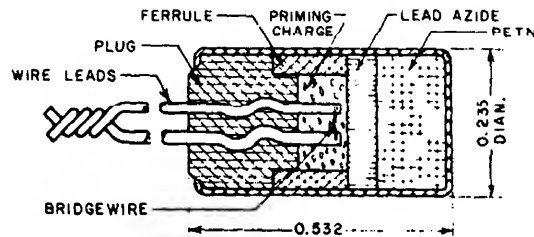

Description: An electric detonator is an initiator that produces a detonation when an electric current is applied. The electric detonator is usually in the form of a metal cylinder. It is closed by an insulating plug through which leads enter the device. The mechanism of initiation may be a heated bridgewire, exploding bridgewire, conductive primer mix or spark gap. Electric detonators are used to initiate high explosives.

Comments: This item was tested. It is effective.

Reference: AMCP 706-179, Explosive Trains, Army Materiel Command, Mar 1965, page 63.

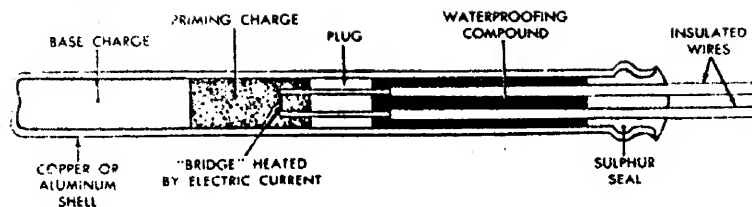

ELECTRIC BLASTING CAP

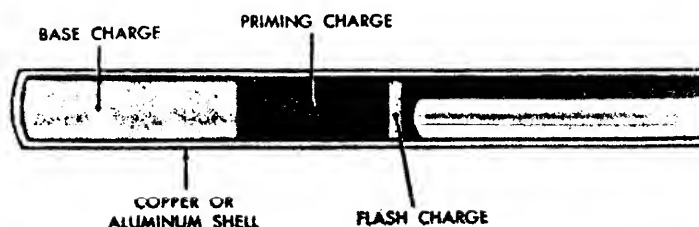

NON-ELECTRIC BLASTING CAP

Description: A blasting cap consists of a tubular metallic shell, approximately $2\frac{1}{2}$ inches long and $\frac{1}{4}$ -inch in diameter, filled with a sensitive high explosive. It acts like an initiator and is used to detonate high explosive charges. There are electric and nonelectric types manufactured in various strengths to meet the requirements of users. Blasting caps are sensitive to shock, friction, and heat, and must be handled carefully. The electric type has two wires for attaching to a battery or other electrical source. The nonelectric type may be crimped to safety fuse or detonating cord. The electric type is packed 50 to a carton and the nonelectric type 100 to a box or can.

Comments: These items were tested. They are workable.

References: TM 9-1900, Ammunition, General, page 275.

FM 5-25, Explosives and Demolitions, pages 14 and 34.

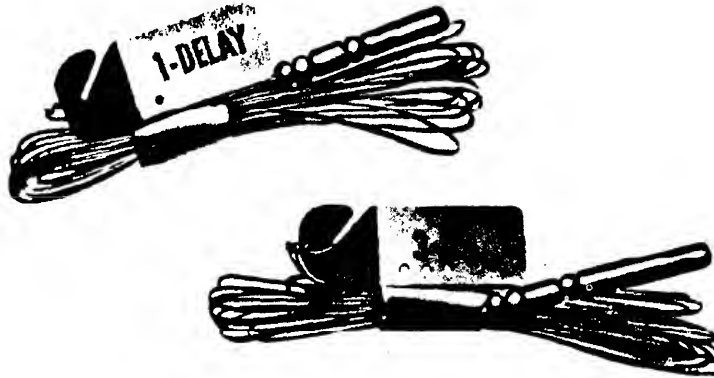

Description: Delay electric blasting caps are similar to standard electric blasting caps except that a delay element is located between the priming charge and the detonating base charge. Delay caps are used when it is necessary to fire blasting charges in rotation. Many delay times are available, ranging from 0.025 seconds to 2.5 seconds. However military delay blasting caps are issued with delay of approximately 1, 1.18, 1.35 and 1.53 seconds only, called 1st, 2nd, 3rd and 4th delay.

Comments: This item was tested. It is effective.

Reference: FM 5-25, Explosives and Demolitions, page 34.

ELECTRIC SQUIB

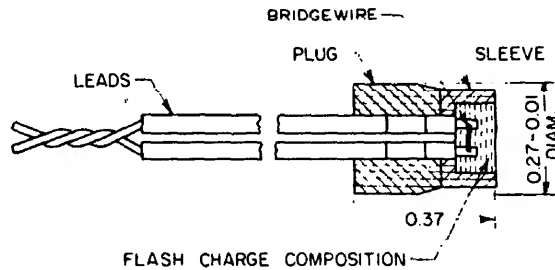

Description: An electric squib is essentially a primer that is used to initiate low explosives. Its housing is a cylindrical cup containing the initiating material. The cup is closed by an insulating plug through which the lead wires enter the squib. A high resistance bridgewire is connected between the leadwires in the interior of the squib; this ignites the priming charge when heated by electric current flow from a battery. When ignited, the initiating explosives burst the case of the squib, pro-

ducing a flash that will initiate low explosives, pyrotechnics, or rocket propellants.

Comments: This item was tested. It is effective.

Reference: AMCP 707-179, Explosive Trains, Army Materiel Command, Mar 1965, page 63.

PERCUSSION PRIMER

11-7

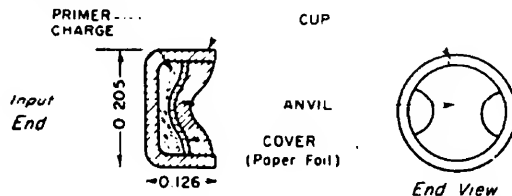

Description: A percussion primer is an initiator intended for mechanical initiation by a firing pin. A rounded firing pin is used that does not pierce the metal container. For this reason percussion primers require higher input energy than stab initiators. Percussion primers are used in fuzes and in fixed ammunition where they initiate propellant by their flash output.

Comments: This item was tested. It is effective.

Reference: TM 9-1900, Ammunition, General, page 141.

STAB PRIMER

11-8

Description: A stab primer is an initiator that is activated when a firing pin pierces its case and ignites a sensitive priming charge by impact and friction. The output from a stab primer is a flash that will initiate propellants or low explosives. The primer is a metal cylindrical cup loaded with explosive and covered with a closing disk.

Comments: This item was tested. It is effective.

Reference: AMCP 706-179, Explosive Trains, Army Materiel Command, Mar 1965, page 63.

FLN ELECTRIC DETONATOR

11-9

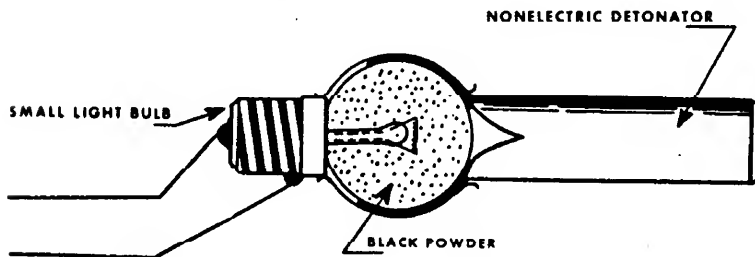

Description: This device consists of a small light bulb and two electric wires. One wire is soldered to the shell and the other to the center contact, as illustrated. A small portion of the glass is cut away, and the empty glass envelope is filled with black powder. A nonelectric detonator taped to the envelope completes the assembly. The two wires are then attached to a switch and battery. When the switch is closed, the bulb filament heats to incandescence and ignites the black powder causing the detonator to fire.

Comments: The test history of this item is not known. The device appears to be workable.

Reference: (C) FSTC 381-5012, Typical Foreign Unconventional Warfare Weapons (U), Army Materiel Command, Sep 1964, page 27.

Section 12. LOW EXPLOSIVES

BLACK POWDER

12-1

Description: Black powder is a mixture of approximately 10% sulfur, 15% charcoal, and 75% sodium or potassium nitrate. It is manufactured in granular and pellet form. In the granular form it is a loose, free flowing, grained material and its burning rate is controlled by grain size; the finer the granulation the faster the burning. Pellets are produced when granular powder is compressed into pellet form. Each pellet has a hole through its center. Pellets are less dangerous to handle, are more efficient, and more economical to use than granular powder. Black powder is extremely sensitive to flame or spark and may be initiated with a time fuse or electric squib. The granular form of black powder is issued in 25-pound drums. The pellet form is issued in 50-pound wooden cases.

Comments: This material was tested. It is effective.

References: TM 9-1900, Ammunition, General, page 45.
TM 9-1910, Military Explosives, page 36.

FRENCH AMMONAL

12-2

Description: French ammonal is an easily improvised low explosive mixture of 86% ammonium nitrate, 6% stearic acid, and 8% aluminum powder. It is generally less effective than an equal weight of TNT. The material is loaded by pressing it into a suitable container. Initiation by an Engineer's special blasting cap is recommended.

Comments: This material was tested. It is effective.

Reference: TM 31-201-1, Unconventional Warfare Devices and Techniques, para 1401.

Section 13. PRIMARY HIGH EXPLOSIVES

MERCURY FULMINATE

13-1

Description: Mercury fulminate is an initiating explosive, commonly appearing as white or gray crystals. It is extremely sensitive to initiation by heat, friction, spark or flame, and impact. It detonates when initiated by any of these means. It is pressed into containers, usually at 3000 psi, for use in detonators and blasting caps. However, when compressed at greater and greater pressure (up to 30,000 psi), it becomes "dead pressed." In this condition, it can only be exploded by another initial detonating agent. Mercury fulminate gradually becomes inert when stored continuously above 100° F. A dark-colored product of deterioration gives evidence of this effect. Mercury fulminate is stored underwater except when there is danger of freezing. Then it is stored under a mixture of water and alcohol.

Comments: This material was tested. It is effective.

References: TM 9-1900, Ammunition, General, page 59.

TM 9-1910, Military Explosives, page 98.

LEAD STYPHNATE

13-2

Description: Lead styphnate is an initiating explosive, commonly appearing in the form of orange or brown crystals. It is easily ignited by heat and static discharge but cannot be used to initiate secondary high explosives reliably. Lead styphnate is used as an igniting charge for lead azide and as an ingredient in priming mixtures for small arms ammunition. In these applications, it is usually mixed with other materials first and then pressed into a metallic container (detonators and primers). Lead styphnate is stored under water except when there is danger of freezing. Then it is stored under a mixture of water and alcohol.

Comments: This item was tested. It is effective.

References: TM 9-1900, Ammunition, General, page 59.

TM 9-1910, Military Explosives, page 107.

LEAD AZIDE

13-3

Description: Lead azide is an initiating explosive and is produced as a white to buff crystalline substance. It is a more efficient detonating agent than mercury fulminate and it does not decompose on long continued storage at moderately elevated temperatures. It is sensitive to both flame and impact but requires a layer of lead styphnate priming mixture to produce reliable initiation when it is used in detonators that are initiated by a firing pin or electrical energy. It is generally loaded into aluminum detonator housings and must not be loaded into housing of copper or brass because extremely sensitive copper azide can be formed in the presence of moisture.

Comments: This material was tested. It is effective.

References: TM 9-1900, Ammunition, General, page 60.
TM 9-1910, Military Explosives, page 103.

DDNP

13-4

Description: DDNP (diazodinitrophenol) is a primary high explosive. It is extensively used in commercial blasting caps that are initiated by black powder safety fuse. It is superior to mercury fulminate in stability but is not as stable as lead azide. DDNP is desensitized by immersion in water.

Comments: This material was tested. It is effective.

References: TM 9-1900, Ammunition, General, page 60.
TM 9-1910, Military Explosives, page 103.

Section 14. SECONDARY HIGH EXPLOSIVES

TNT

14-1

Description: TNT (Trinitrotoluene) is produced from toluene, sulfuric acid, and nitric acid. It is a powerful high explosive. It is well suited for steel cutting, concrete breaching, general demolition, and for underwater demolition. It is a stable explosive and is relatively insensitive to shock. It may be detonated with a blasting cap or by primacord. TNT is issued in 1-pound and ½-pound containers and 50-pounds to a wooden box.

Comments: This material was tested. It is effective. TNT is toxic and its dust should not be inhaled or allowed to contact the skin.

References: TM 9-1900, Ammunition, General, page 263.
FM 5-25, Explosives and Demolitions, page 3.

NITROSTARCH

14-2

Description: Nitrostarch is composed of starch nitrate, barium nitrate, and sodium nitrate. It is more sensitive to flame, friction, and impact than TNT but is less powerful. It is initiated by detonating cord. Nitrostarch is issued in 1-pound and 1½-pound blocks. The 1-pound packages can be broken into ¼-pound blocks. Fifty 1-pound packages and one hundred 1½-pound packages are packed in boxes.

Comments: This material was tested. It is effective.

Reference: TM 9-1900, Ammunition, General, page 263.

TETRYL

14-3

Description: Tetryl is a fine, yellow, crystalline material and exhibits a very high shattering power. It is commonly used as a booster in ex-

plosive trains. It is stable in storage. Tetryl is used in detonators. It is pressed into the bottom of the detonator housing and covered with a small priming charge of mercury fulminate or lead azide.

Comments: This material was tested. It is effective.

References: TM 9-1900, Ammunition, General, page 52.

TM 31-201-1, Unconventional Warfare Devices and Techniques, para 1509.

RDX

14-4

Description: RDX (cyclonite) is a white crystalline solid that exhibits very high shattering power. It is commonly used as a booster in explosive trains or as a main bursting charge. It is stable in storage, and when combined with proper additives, may be cast or press loaded. It may be initiated by lead azide or mercury fulminate.

Comments: This material was tested. It is effective.

References: TM 9-1900, Ammunition, General, page 52.

TM 31-201 1, Unconventional Warfare Devices and Techniques, para 1501.

NITROGLYCERIN

14-5

Description: Nitroglycerin is manufactured by treating glycerin with a nitrating mixture of nitric and sulfuric acid. It is a thick, clear to yellow-brownish liquid that is an extremely powerful and shock-sensitive high explosive. Nitroglycerin freezes at 56° F., in which state it is less sensitive to shock than in liquid form.

Comments: This material was tested. It is effective.

References: TM 9-1910, Military Explosives, page 123.

TM 31-201-1, Unconventional Warfare Devices and Techniques, para 1502.

COMMERCIAL DYNAMITE

14-6

Description: There are three principal types of commercial dynamite: straight dynamite, ammonia dynamite, and gelatin dynamite. Each type is further subdivided into a series of grades. All dynamites contain nitroglycerin in varying amounts and the strength or force of the explosive is related to the nitroglycerin content. Dynamites range in velocity of detonation from about 4000 to 23,000 feet per second and are sensitive to shock. The types and grades of dynamite are each used for specific purposes such as rock blasting or underground explosives. Dynamite is initiated by electric or nonelectric blasting caps. Although dynamites are furnished in a wide variety of packages, the most common unit is the ½ pound cartridge. Fifty pounds is the maximum weight per case.

Comments: This material was tested. It is effective.

References: TM 9-1900, Ammunition, General, page 266.
FM 5-25, Explosives and Demolitions, page 8.

MILITARY DYNAMITE

14-7

Description: Military (construction) dynamite, unlike commercial dynamite, does not absorb or retain moisture, contains no nitroglycerine, and is much safer to store, handle, and transport. It comes in standard sticks $1\frac{1}{4}$ inches in diameter by 8 inches long, weighing approximately $\frac{1}{2}$ pound. It detonates at a velocity of about 20,000 feet per second and is very satisfactory for military construction, quarrying, and demolition work. It may be detonated with an electric or nonelectric military blasting cap or detonating cord.

Comments: This material was tested. It is effective.

References: FM 5-25, Explosives and Demolitions, page 7.
TM 9-1910, Military Explosives, page 204.

AMATOL

14-8

Description: Amatol is a high explosive, white to buff in color. It is a mixture of ammonium nitrate and TNT, with a relative effectiveness slightly higher than that of TNT alone. Common compositions vary from 80% ammonium nitrate and 20% TNT to 40% ammonium nitrate and 60% TNT. Amatol is used as the main bursting charge in artillery shell and bombs. Amatol absorbs moisture and can form dangerous compounds with copper and brass. Therefore it should not be housed in containers of such metals.

Comments: This material was tested. It is effective.

References: FM 5-25, Explosives and Demolitions, page 7.
TM 9-1910, Military Explosives, page 182.

PETN

14-9

Description: PETN (pentaerythrite tetranitrate), the high explosive used in detonating cord, is one of the most powerful of military explosives, almost equal in force to nitroglycerine and RDX. When used in detonating cord, it has a detonation velocity of 21,000 feet per second and is relatively insensitive to friction and shock from handling and transportation.

Comments: This material was tested. It is effective.

References: FM 5-25, Explosives and Demolitions, page 7.
TM 9-1910, Military Explosives, page 135.
TM 31-201-1, Unconventional Warfare Devices and Techniques, para 1508.

BLASTING GELATIN**14-10**

Description: Blasting gelatin is a translucent material of an elastic, jellylike texture and is manufactured in a number of different colors. It is considered to be the most powerful industrial explosive. Its characteristics are similar to those of gelatin dynamite except that blasting gelatin is more water resistant.

Comments: This material was tested. It is effective.

Reference: TM 9-1910, Military Explosives, page 204.

COMPOSITION B**14-11**

Description: Composition B is a high-explosive mixture with a relative effectiveness higher than that of TNT. It is also more sensitive than TNT. It is composed of RDX (59%), TNT (40%), and wax (1%). Because of its shattering power and high rate of detonation, Composition B is used as the main charge in certain models of bangalore torpedoes and shaped charges.

Comments: This material was tested. It is effective.

References: FM 5-25, Explosives and Demolitions, page 7.

TM 9-1900, Ammunition, General, page 57.

TM 9-1910, Military Explosives, page 193.

COMPOSITION C4**14-12**

Description: Composition C4 is a white plastic high explosive more powerful than TNT. It consists of 91% RDX and 9% plastic binder. It remains plastic over a wide range of temperatures (-70° F. to 170° F.), and is about as sensitive as TNT. It is eroded less than other plastic explosives when immersed under water for long periods. Because of its high detonation velocity and its plasticity, C4 is well suited for cutting steel and timber and for breaching concrete.

Comments: This material was tested. It is effective.

Reference: TM 9-1910, Military Explosives, page 204.

AMMONIUM NITRATE**14-13**

Description: Ammonium nitrate is a white crystalline substance that is extremely water absorbent and is therefore usually packed in a sealed metal container. It has a low velocity of detonation (3600 fps) and is used primarily as an additive in other explosive compounds. When it is used alone, it must be initiated by a powerful booster or primer. It is only 55% as powerful as TNT, hence larger quantities are required to produce similar results.

Comments: This material was tested. It is effective.

Caution: Never use copper or brass containers because ammonium nitrate reacts with these metals.

References: TM 9-1900, Ammunition, General, page 264.

TM 9-1910, Military Explosives, page 119.

HMX**14-14**

Description: HMX is a solid high explosive commonly used as a booster, and sometimes used as a main charge where its shattering effect is needed. It is a white substance and has a rather high melting point; hence it is usually pressed into its container. It may be initiated by lead azide or mercury fulminate.

Comments: This material was tested. It is effective.

Reference: TM 9-1910, Military Explosives, page 181.

PENTOLITE**14-15**

Description: Pentolite is a high explosive mixture of equal proportions of PETN and TNT. It is light yellow and is used as the main bursting charge in grenades, small shells, and shaped charges. Pentolite may be melted and cast in the container. Pentolite should not be drilled to produce cavities, forming tools should be used.

Comments: This material was tested. It is effective.

Reference: TM 9-1900, Ammunition, General, page 55.

PICRIC ACID**14-16**

Description: Picric acid is a yellow crystalline, high explosive bursting charge. It is initiated by lead azide or mercury fulminate. Picric acid has the same effectiveness as TNT. In loading operations, pressing is recommended; however, picric acid can be melted and poured if there is assurance of low lead content or no contact with lead. Picric acid in contact with lead produces lead picrate, a sensitive and violent explosive.

Comments: This material was tested. It is effective.

References: TM 9-1910, Military Explosives, page 159.

TM 31-201-1, Unconventional Warfare Devices and Techniques, para 1510.

GUN COTTON**14-17**

Description: Gun cotton is a nitrocellulose explosive made from cotton fibers, containing 13% or more of nitrogen. Although primarily considered a propellant, it is sometimes used as a base charge in electric primers and electrically initiated destructors because it will detonate with proper confinement.

Comments: This material was tested. It is effective.

References: TM 9-1910, Military Explosives, page 127.

TM 9-1900, Ammunition, General, page 40.

AMMONAL**14-18**

Description: Ammonal is a high explosive mixture composed of 22% ammonium nitrate, 67% TNT, and 11% flaked or powdered aluminum. It is sometimes used as a filler for artillery shell. The composition is 83% as effective as TNT and it explodes with a bright flash on detonation.

Comments: This material was tested. It is effective.

Reference: TM 9-1910, Military Explosives, pages 184 and 214.

IMPROVISED PLASTIC EXPLOSIVE FILLER**14-19**

Description: Plastic explosive filler can be made from potassium chlorate and petroleum jelly. The potassium chlorate crystals are ground into a very fine powder and then mixed with the petroleum jelly. This explosive can be detonated with a No. 8 commercial blasting cap or with any military blasting cap. The explosive must be stored in a waterproof container until ready to use.

Comments: This material was tested. It is effective.

Reference: TM 31-210, Improvised Munitions, sec I, No. 1.

TETRYTOL**14-20**

Description: Tetrytol is a high explosive bursting charge containing 75% tetryl and 25% TNT. It is used as a demolition explosive, a bursting charge for mines, and in artillery shell. The explosive force of tetrytol is approximately the same as that of TNT. It may be initiated by a blasting cap. Tetrytol is usually loaded by casting.

Comments: This material was tested. It is effective.

References: TM 9-1900, Ammunition, General, page 55.

TM 9-1910, Military Explosives, page 188.

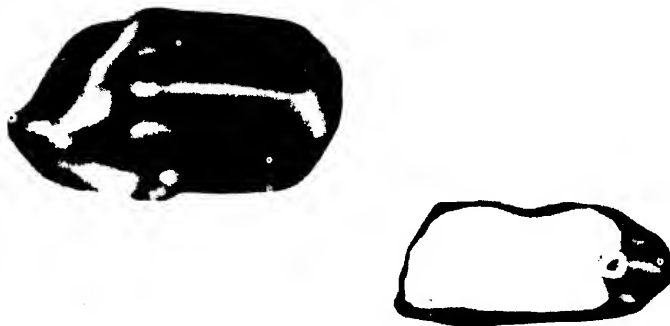
JAPANESE EXPLOSIVE COAL**14-21**

Description: This material consists of thin earthenware containers of irregular sizes and shapes that are coated with a black bitumin paint to give them the appearance of anthracite coal. Each container is filled with explosive (RDX) and contains an igniter. The igniter is a copper tube with a detonator at one end and a small black powder charge at the other end. When the device is exposed to heat, the black powder is ignited and in turn initiates the detonator and main charge.

Comments: The test history of this material is not known. The explosive is presumed to be effective.

References: TM 9-1985-4, Japanese Explosive Ordnance, page 259.
(C) FSTC 381-5012, Typical Foreign Unconventional Warfare Weapons (U), Army Materiel Command, Sep 1964, page 49.

GERMAN EXPLOSIVE COAL

14-22



Description: This material consists of genuine pieces of coal that are drilled and filled with explosive and a detonator. The holes are then sealed with modeling clay or putty that is then blackened with shoe polish. When the device is exposed to heat, it explodes.

Comments: The test history of this material is not known. The explosive is presumed to be effective.

Reference: (C) FSTC 381-5012, Typical Foreign Unconventional Warfare Weapons (U), Army Materiel Command, Sep 1964, page 48.

Section 15. TECHNIQUES AND PRECAUTIONS

EXPLOSIVES SAFETY

15-1

Description: Safety is vital when handling explosives. Explosives chemists and other workers in an explosives laboratory must follow strict rules to avoid hazards, to be certain of their own safety, and to protect other personnel and materiel. The personnel concerned must be familiar with the following practices.

1. General laboratory safety, good housekeeping, procedures for handling ordinary laboratory chemicals and equipment.
2. Techniques for evaluation of new explosive materials and experimental compounds. Special care is required when handling materials having unknown properties.
3. Examination of compounds, mixtures, and reactions that are or may be hazardous.
4. Methods for storing explosives and disposing of laboratory samples that are no longer needed.
5. References to sources of information and to work of others.

Comments: These techniques were tested. They are effective. While the handbook described was prepared as a guide to laboratory safety at Picatinny Arsenal, it is useful in any explosives laboratory. The sections covering the evaluation of new compounds and the list of hazardous materials and reactions will be of value to explosives chemists

Reference: Explosives Research Section Safety Handbook, Explosives and Propellants Laboratory, Picatinny Arsenal, Dec 1959.

Section 16. GAS AND DUST EXPLOSIVES

FLAMMABILITY OF GASES

16-1

Description: Under some conditions, common gases act as a fuel. When mixed with air, they will burn rapidly or even explode. For some fuel-air mixtures, the range over which explosion can occur is quite wide while for others the limits are narrow. The upper and lower amounts of common fuels that will cause an ignitable mixture are shown in the table below. The quantity shown is the percentage by volume of air. If the fuel-air mixture is too lean or too rich, it will not ignite. The amounts shown are therefore called limits of inflammability.

<i>Fuel</i>	<i>Gases (% by volume of air)</i>	
	<i>Lower Limit</i>	<i>Upper Limit</i>
Water gas or blue gas	7.0	72
Natural gas	4.7	15
Hydrogen	4.0	75
Acetylene	2.5	81
Propane	2.2	10
Butane	1.9	9

Comments: These fuels have been tested under laboratory conditions. They are effective. Ignition depends on method of initiation, uniformity of mixture, and physical conditions.

Reference: Bulletin 279, Limits of Inflammability of Gases and Vapors
H. F. Coward and G. W. Jones, Bureau of Mines, U. S.
Government Printing Office, 1939.

CHAPTER 20. APPLICATIONS OF EXPLOSIVES

Section 21. BASIC DEMOLITION TECHNIQUES

TIMBER CUTTING

21-1

Description: Charges used for cutting timber, such as wooden beams, posts, or trees are readily placed by tying them around the girth of the timber. The charge should be concentrated as much as possible and placed on the widest face of the timber. A tree, post, or piling when cut in this manner will tend to fall toward the side on which the charge is placed. Plastic explosive or high explosive blocks may be used. The charge weight required may be estimated from the following formula:

$$W = D^2/40$$

where W = required charge weight in pounds

D = smallest dimension of timber in inches.

Comments: This technique was tested. It is effective.

Reference: FM 5-25, Explosives and Demolitions, page 87.

STEEL CUTTING

21-2

Description: Steel cutting charges are used to sever steel girders or structural members. To cut a steel member, place the explosive on one side of the section along the desired break line. The larger portion of the charge should be nearest the area of greatest cross section. Where it is necessary to place the charge on both sides of the member, the charges on one side should be slightly offset from the other to produce a shearing action. Plastic explosive or explosive blocks may be used. Charge size may be estimated from the following formula:

$$W = KA$$

where W = the weight of explosive in pounds

A = the cross section area of the steel in square inches

K = a factor varying from $\frac{3}{8}$ to 1 depending on the conformance of contact between the charge and the plate.

Comments: This technique was tested. It is effective.

Reference: FM 5-25, Explosives and Demolitions, page 83.

Section 22. DEMOLITION CHARGES

WINE BOTTLE CONE CHARGE

22-1

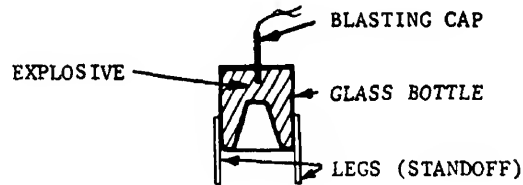

Description: This device makes use of a glass wine bottle having a cone shaped bottom. The lower portion of the bottle is cut off and an explosive charge packed therein. A blasting cap, inserted in the explosive, is used to detonate the charge. Legs are taped to the bottom to provide standoff distance for optimum penetration. Thus constructed, the device becomes a shaped charge having directional penetration of 3 to 4 inches of steel armor plate.

Comments: This item was tested. It is effective.

Reference: TM 31-210, Improvised Munitions, sec II, No. 3.

BANGALORE TORPEDO

22-2

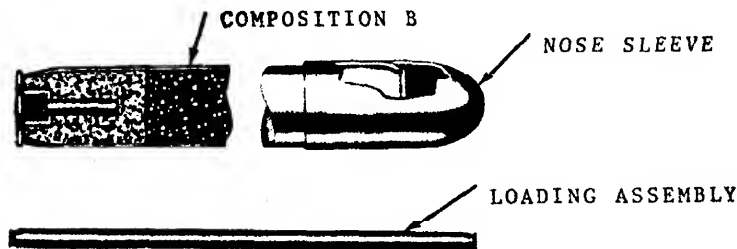

Description: The bangalore torpedo clears a path 10 to 15 feet wide through barbed wire entanglements. In minefield breaching, it will explode all antipersonnel mines and most antitank mines in a narrow foot path. Both military electric or nonelectric blasting caps will detonate the bangalore torpedo. It consists of loading assemblies, connecting sleeves, and a nose cone. Each loading assembly, which may be used singly or connected in a series of loading assemblies, is five feet long and $2\frac{1}{8}$ inches in diameter. It contains $8\frac{1}{2}$ pounds of Composition B explosive and weighs 13 pounds.

Comments: This item was tested. It is effective.

Reference: FM 5-25, Explosives and Demolitions, page 10.

PROJECTED CHARGE DEMOLITION KIT, M1**22-3**

Description: This projected, flexible, linear charge is designed to clear a path 1 foot wide through antipersonnel minefields. One soldier fires the complete assembly. First the kit is emplaced, after which a fuze lighter on a jet propulsion unit is pulled. A 15 second delay in the propulsion fuze allows the soldier to pull the fuze lighter safety pin and the firing ring on the detonating cable and take cover at least 100 feet behind the assembly.

Comments: This item was tested. It is effective.

Reference: FM 5-25, Explosives and Demolitions, page 13.

ROCKET-PROPELLED BANGALORE TORPEDO (BARNEY GOOGLE) 22-4

Description: The rocket-propelled bangalore torpedo is used chiefly to clear a path through barbed wire entanglements, antipersonnel mines, and similar obstacles. Rocket propulsion enables deeper penetration of small obstacles with less chance of exposing soldiers to enemy observation and fire. Twenty sections of bangalore torpedos can be joined together by special connecting sleeves to form a 100-foot long train. The rocket motor is attached to the front of the train to provide propulsion.

Comments: This item was tested. It is effective.

Reference: FM 5-25, Explosives and Demolitions, page 11.

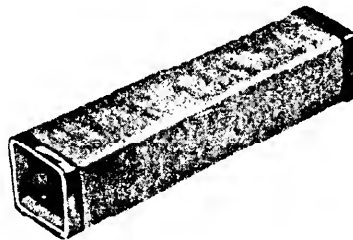
DEMOLITION BLOCK M5A1**22-5**

Description: Demolition block M5A1 is a 2½ pound block of Composition C4 plastic explosive. It is 11 inches long by 2 inches square. The block may be detonated as received or molded by hand and packed into close contact with irregular objects. One method of initiation is by forming a ball of explosive around detonating cord that is tied in a double knot. Each block is wrapped in a plastic covering and has a threaded cap well at either end for use as a block explosive. Because of its high detonation velocity and its plasticity, C4 is well suited for cutting steel and timber, and for breaching concrete. It may be used

under water if inclosed in the original or in an improvised container to prevent erosion by stream currents.

Comments: This item was tested. It is effective.

References: FM 5-25, Explosives and Demolition, page 6.

TM 9-1900, Ammunition, General, page 263.

DEMOLITION BLOCK, M2

22-6

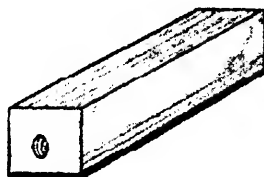

Description: The M2 demolition block is a block of tetrytol explosive. It is similar to the M1 chain block except that it has a threaded cap well in each end but has no core of detonating cord. It is 11 inches long by 2 inches square. A tetryl booster pellet, cast into the block, surrounds each cap well. The M2 demolition block is used in the same manner as the M1 block for cutting and breaching. Explosive chains may be made by connecting a series of blocks with detonating cord.

Comments: This item was tested. It is effective.

References: FM 5-25, Explosives and Demolitions, page 5.

TM 9-1900, Ammunition, General, page 262.

EXPLOSIVE BLOCKS, TNT

22-7

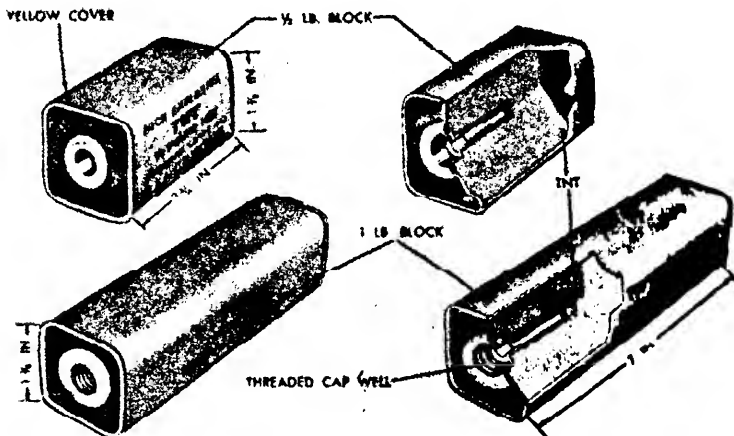

Description: TNT is issued in ½ and 1 pound blocks that are packed in a wooden box. Explosive, TNT, ½ pound block, is packed in a yellow container 1⅞ inches square and 3¾ inches long. Explosive, TNT, 1 pound block, is packed in an olive-drab container 1⅞ inches square and 7 inches long. Each box weighs 50 pounds. Both blocks have cap wells in one end to receive a blasting cap, detonator, or firing device.

Comments: These items were tested. They are effective.

Reference: TM 9-1900, Ammunition, General, page 263.

CRATERING CHARGE, AMMONIUM NITRATE

22-8

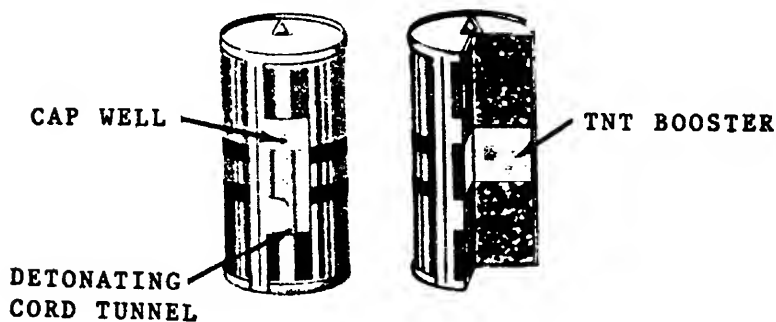

Description: This explosive cratering charge is a 40 pound charge of ammonium nitrate in a cylindrical metal container. The central section of the charge consists of a TNT booster, while the ammonium nitrate is loaded at both ends. A cap well and a detonating cord tunnel are located in the central section of the charge. The charge is generally used for blasting craters in roads.

Comments: This item was tested. It is effective.

Reference: TM 9-1900, Ammunition, General, page 264.

DEMOLITION BLOCK, M3

22-9



Description: The M3 demolition block is a $2\frac{1}{4}$ pound block of Composition C3, 11 inches long by 2 inches square. The block is wrapped in glazed paper and inclosed in a labeled olive-drab cardboard carton. It is a more powerful explosive than TNT. Its sensitivity and stability are comparable to those of TNT. The block may be detonated by a blasting cap or by primacord. Eight blocks are packed in a cloth bag and two bags are packed in a wooden box.

Comments: This item was tested. It is effective.

References: TM 9-1900, Ammunition, General, page 262.

FM 5-25, Explosives and Demolitions, page 5.

DEMOLITION BLOCK, M1

22-10

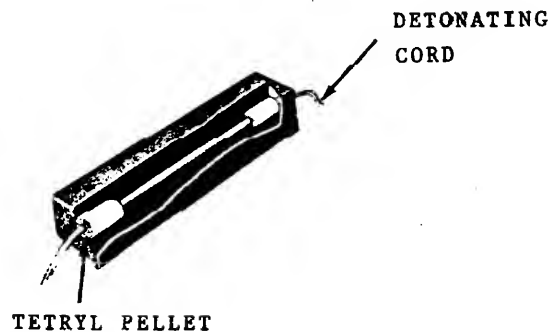

Description: This item consists of eight $2\frac{1}{2}$ pound blocks of tetrytol, 11 inches long by 2 inches square, spaced $\frac{1}{8}$ inches apart. The blocks are cast onto a single line of detonating cord passing lengthwise through them. A two-foot length of detonating cord is left free at each end of the chain of blocks. As tetrytol is relatively insensitive to shock, a $\frac{1}{2}$ ounce tetryl booster is cast into each end of the block so that it may be detonated. Otherwise, tetrytol is similar to TNT and is suited for any demolition purpose for which TNT is used. One chain of blocks is packed in a standard carrying bag and two bags (16 blocks, 40 pounds) are packed in a wooden box.

Comments: This item was tested. It is effective.

References: TM 9-1900, Ammunition, General, page 262.

FM 5-25, Explosives and Demolitions, page 4.

NITRAMON CRATERING CHARGE

22-11



Description: This cratering charge contains a blasting agent comparable to ammonium nitrate. The nitramon is not removed from its metal waterproof container for cratering operations because it absorbs water. The charge is usually issued in cylindrical, waterproof, metal containers, 7 inches in diameter and 24 inches long. The charge and container weigh 43 pounds. The container has a ring on top for general handling and lowering into bore holes. Nitramon, generally used in cratering, is also effective in ditching and quarrying.

Comments: This item was tested. It is effective.

Reference: FM 5-25, Explosives and Demolitions, page 9.

SHAPED CHARGE, M3

22-12

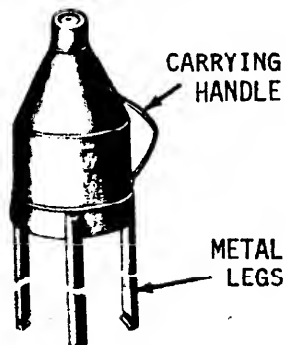

Description: The M3 shaped charge is capable of penetrating a 5 foot thick wall of concrete or 20 inches of armor plate. It is constructed of a sheetmetal container, steel cone liner, and 29½ pounds of 50-50 pentolite or 30 pounds of Composition B. Standoff is provided by a detachable metal stand, optimum standoff distance is 5 feet. The charge contains a threaded cap well for inserting a blasting cap. It has a carrying handle and weighs 40 pounds.

Comments: This item was tested. It is effective. The charge made 7 inch diameter holes, 6 to 9 feet deep, through 10 inches of concrete on top of 21 inches rock base and compacted soil.

References: FM 5-25, Explosives and Demolitions, page 9.

Report 1815, Evaluation of M2A3 and M3 Shaped Charges for Blasting Cratering Charge Boreholes in Concrete Pavements, J. A. Dennis, U.S. Army Engineer Research and Development Laboratories. Jul 1965.

SHAPED CHARGE, M2A3

22-13

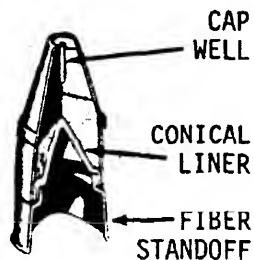

Description: The M2A3 shaped charge is capable of penetrating a 3 foot thick wall of reinforced concrete or 1 foot of armor plate. It is constructed of a molded fiber container, high-density glass cone liner, and 11½ pounds of 50-50 pentolite or Composition B. Standoff is provided by a molded fiber sleeve, optimum standoff distance is 3½ feet. The charge contains a threaded cap well for receiving a blasting cap. It weighs 15 pounds.

Comments: This item was tested. It is effective. The charge made 2 inch diameter holes, 4 to 7½ feet deep through 10 inches of concrete on top of 21 inches rock base and compacted soil.

References: FM 5-25, Explosives and Demolitions, page 9.

Report 1815, Evaluation of M2A3 and M3 Shaped Charger for Blasting Cratering Charge Boreholes in Concrete Pavements, J. A. Dennis, U.S. Army Engineer Research and Development Laboratories, Jul 1965.

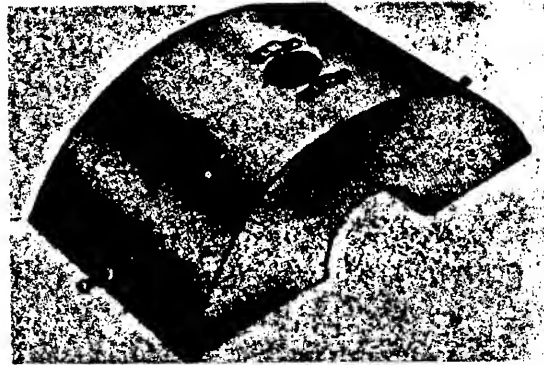

Description: This charge, No. 2, MK I, is nicknamed "General Wade." It is an arched linear charge containing 26 pounds of pentolite. The device is made of sheet metal and measures 9 by $12\frac{3}{4}$ by $6\frac{3}{8}$ inches. The container is semicylindrical with an arch of $2\frac{1}{4}$ inch radius formed in the bottom to produce a cavity-charge effect. The device is designed to be a general purpose charge, combining some of the advantages of a cone charge with those of the ordinary contact type charge. It is effective against reinforced concrete and armor plate up to 2 inches in thickness.

Comments: The test history of this item is not known. The item is presumed to be effective.

Reference: (C) TM 9-1985-1, British Explosive Ordnance (U), page 445.



description: The Beehive No. 1, Mk III demolition charge is a ten pound device containing $6\frac{3}{4}$ pounds of pentolite. It measures 6 inches diameter by 7 inches long and has three $4\frac{1}{2}$ inch legs to provide the proper stand-off distance. An 80° sheet steel cone is formed in one end to produce a cavity-charge effect. A removable cap on top of the cone covers a tube containing primers into which a detonator is inserted.

Comments: The test history of this item is not known. The item is predicted to be effective.

reference: (C) TM 9-1985-1, British Explosive Ordnance (U), page 445.

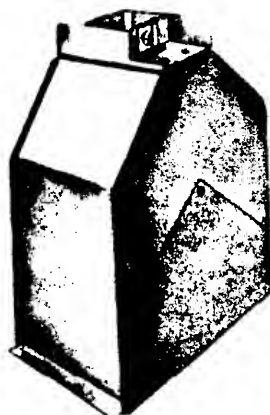

Description: The Hayrick charge No. 3, MK I is a linear-cavity charge designed to cut the tension reinforcing bars of reinforced concrete structures. It consists of a mild steel body containing 15 pounds of pentolite high-explosive and a blast plate, fitted internally, to produce a cavity-charge effect. The body measures $11\frac{1}{4}$ by 6 by $17\frac{1}{2}$ inches high. The bottom is open, while the top is shaped to an apex and carries two detonator sleeves, a sealing plate, and a fuze support. Total weight is $27\frac{1}{2}$ pounds.

Comments: The test history of this item is not known. The item is presumed to be effective.

Reference: (C) TM 9-1985-1, British Explosive Ordnance (U), page 446.

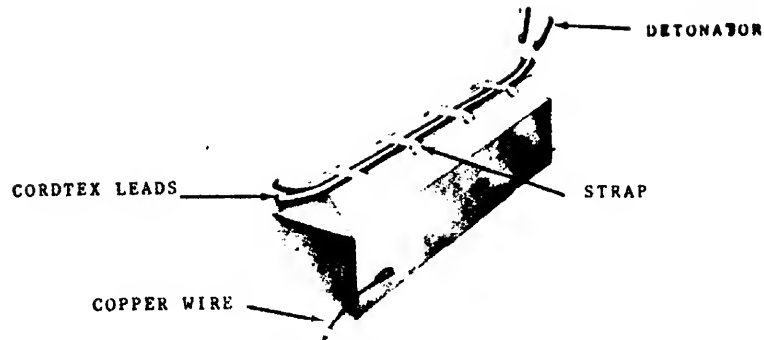

Description: The Mk I and Mk II Stock Demolition Charges are identical except that the Mk I weighs 5 ounces while the Mk II weighs 7 ounces and is 2 inches longer. These devices are small, linear cavity charges. The Mk I is designed to cut 1 inch of steel. Two cordtex leads are inserted in a groove in the top of the charge above a series of primer pellets and are held in place by four straps soldered to the outer casing. A 10 inch tinned copper wire is soldered to each corner of the charge to provide a means for attaching the charge, or for connecting two or more charges together.

Comments: The test history of this item is not known. The device is presumed to be effective.

Reference: (C) TM 9-1985-1, British Explosive Ordnance (U), page 445.

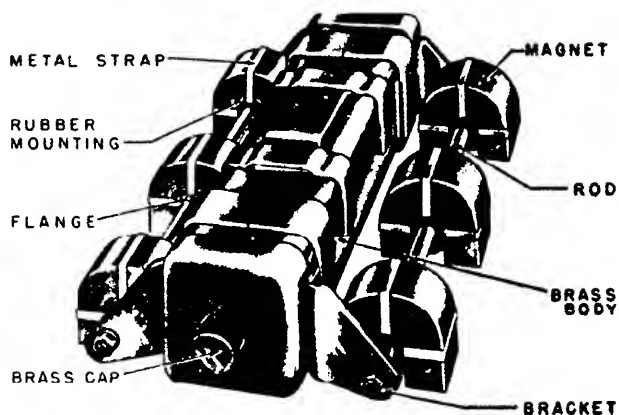

Description: The Rigid Limpet was designed to destroy tanks and damage other steel structures. It is $8\frac{1}{4}$ inches long, and $2\frac{1}{2}$ inches wide and $2\frac{1}{2}$ inches high. The device contains a charge of $2\frac{1}{2}$ pounds of plastic high explosive, molded to accept a detonator at each end. Three U-shaped permanent magnets are loosely mounted with metal straps on each side of the brass body. Rubber mounting of the magnets allows limited movement for attachment to uneven surfaces. The Limpet is fuzed with Delay Igniter, Mk 1.

Comments: The test history of this item is not known. The device is presumed to be effective.

Reference: (C) TM 9-1985-1, British Explosive Ordnance (U), page 448.

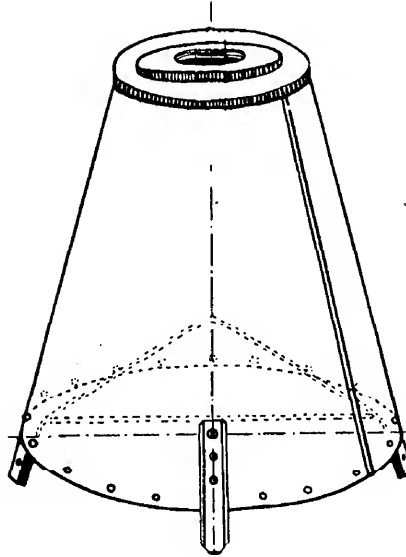

Description: This homemade shaped charge has 3 legs to serve as stand-off. The explosive charge container is constructed of black sheet metal, rolled and hermetically welded. It is 9 inches in diameter, 11 inches high and weighs 21 pounds. The charge contains 13½ pounds of TNT that is ignited electrically.

Comments: The test history of this item is not known. The device appears to be effective.

Reference: Report EODS-65-3, Viet Cong's Explosive Ordnance Used in South Vietnam, U. S. Naval School, Explosive Ordnance Disposal, Jul 1965, page 52.

VIET CONG RIVETED SHAPED CHARGE

22-20

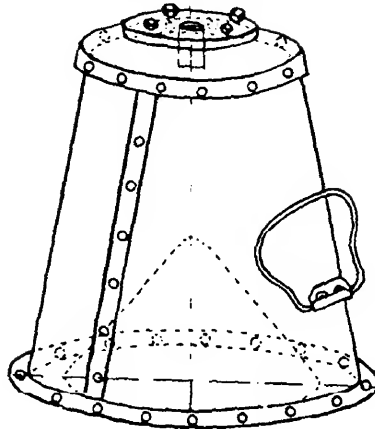

Description: This short pyramidal shaped charge functions by electricity and is constructed of rolled black sheet metal that is fastened together by rivets. It stands 8½ inches high and weighs 17½ pounds. The charge contains 11 pounds of Melinite explosive.

Comments: The test history of this item is not known. The device appears to be effective.

Reference: Report EODS-65-3, Viet Cong's Explosive Ordnance Used in South Vietnam, U. S. Naval School, Explosive Ordnance Disposal, Jul 1965, page 61.

RUSSIAN TNT DEMOLITION BLOCK

22-21

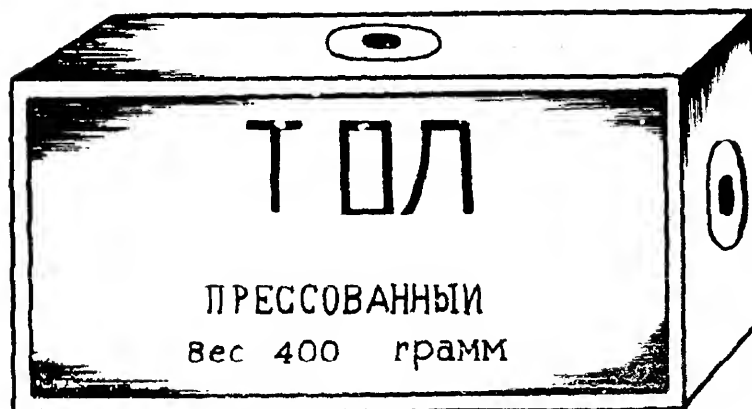

Description: The Russian TNT demolition block is rectangular shaped and has a $\frac{1}{4}$ inch diameter hole in the end of the block. Its size is 2 by 2 by 4 inches and its weight $\frac{3}{4}$ pound. It is covered with wax paper that has an inscription in Russian as to the contents. This demolition block is used as a booster block for all demolition work.

Comments: The test history of this item is not known. The device appears to be effective.

Reference: Report EODS-65-3, Viet Cong's Explosive Ordnance Used in South Vietnam, U. S. Naval School, Explosive Ordnance Disposal, Jul 1965, page 72.

CHINESE COMMUNIST TNT DEMOLITION BLOCK

22-22

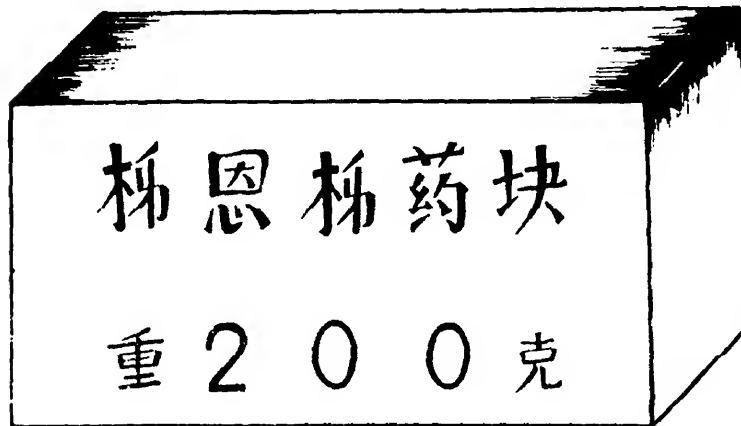

Description: The Chinese Communist TNT demolition block is rectangular in shape, yellowish in color, wrapped in oil paper with Chinese markings on the outside meaning: TNT Demolition block, 200 grams. It is 1 by 2 by 4 inches in size and weighs $\frac{1}{2}$ pound.

Comments: The test history of this item is not known. The device appears to be effective.

Reference: Report EODS-65-3, Viet Cong's Explosive Ordnance Used in South Vietnam, U. S. Naval School, Explosive Ordnance Disposal, Jul 1965, page 73.

Section 23. FUSES

FUSE CORD

23-1

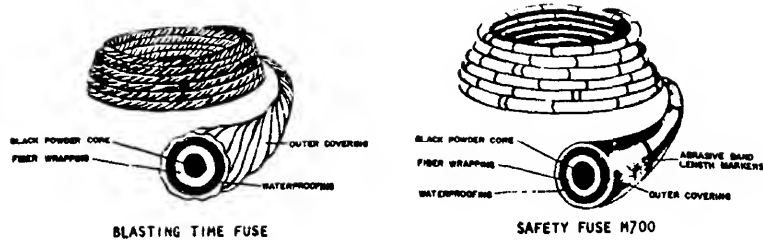

Description: Fuse cord is a flexible fabric tube having a core of low explosive. In the Blasting Time Fuse and Safety Fuse M700 shown above, the explosive is black powder. When ignited at one end, the cord burns to the other end at a fast speed, about 40 seconds per foot. The diameter is about $\frac{1}{4}$ inch. The covering is waterproof but the exposed ends are not. Safety Fuse M700 contains marking rings every 18 inches (1 minute of burning time) for ease of measuring the length to be cut. The markings are made abrasive so that they can be felt in the dark. Fuse cord is initiated by a match or the M2 or M60 U.S. Army fuse lighters. It is used to ignite explosives of the kind that are set off by a flame.

Comments: This item was tested. It is workable. The Blasting Time Fuse (commercial) is not reliably waterproof. Burning rates should always be tested by timing the burning of a one-foot length of fuse after cutting off a minimum of 3 inches on the end to remove powder that may have absorbed moisture.

References: TM 9-1900, Ammunition, General, pages 271 and 272.

TM 31-201-1, Unconventional Warfare Devices and Techniques, para 0101.

IMPROVED STRING FUSE

23-2

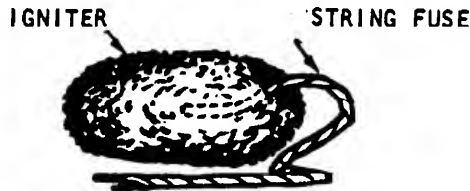

Description: A fast burning fuse (approximately 40 inches per second burning rate) can be made from cotton string and black powder. Three strands of string are twisted together and the black powder, mixed

with water to form a paste, is rubbed into the strings and allowed to dry. A substitute for the black powder can be prepared from potassium nitrate, charcoal, and sulfur. A slow burning fuse (approximately 2 inches per second burning rate) can be made from cotton string or shoelaces and a mixture of potassium nitrate and sugar or potassium chlorate and sugar in water. Three strings or shoelaces are soaked in the chemical solution and then twisted together and allowed to dry. The last few inches of this fuse should be coated with black powder paste to increase ignition intensity. The fuses can be initiated by a match; however, they are not waterproof and will not burn when wet. Both fuses are used to ignite explosives of the kind that are set off by a flame.

Comments: These items were tested. They are workable. The burning rate should be determined by measuring the time it takes to burn a known length.

References: TM 31-210, Improvised Munitions, sec VI, No. 7.

TM 31-201-1, Unconventional Warfare Devices and Techniques, para 0102.

Section 24. FUZES

DETONATING CORD (PRIMACORD)

24-1

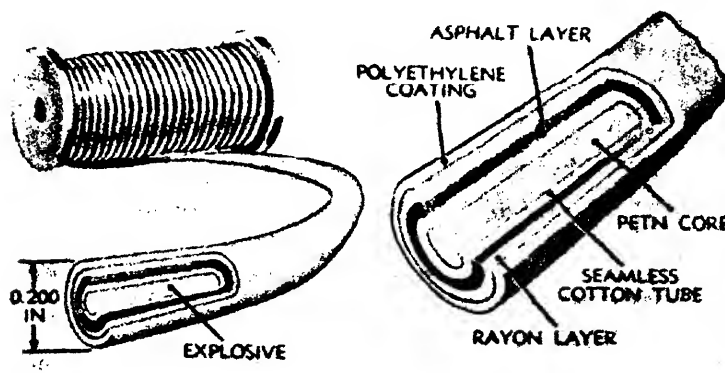

Description: Detonating cord consists of a core of primary high explosive (PETN) within a waterproof covering. It has a velocity of detonation of about 20,000 feet per second and is used for initiating high explosive charges. It is about $\frac{1}{4}$ inch in diameter and contains approximately 40 grains of PETN per foot. Underwater protection is provided by applying an asphalt coating over textile cord and an outer covering of plastic. Detonating cord can be detonated by a No. 6 blasting cap. It is issued in 50, 100, 500, and 1000 foot spools.

Comments: This item was tested. It is workable.

Caution: Detonating cord must not be confused with fuse cord. Fuse cord burns slowly (40 seconds per foot) while detonating cord explodes at once over its entire length.

References: TM 9-1900, Ammunition, General, page 272.

FM 5-25, Explosives and Demolitions, page 51.

PRESSURE FUZE, M1A1

24-2

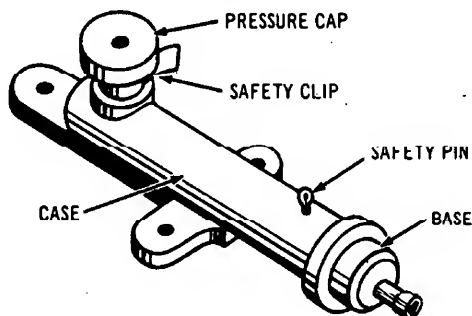

Description: This fuze is designed to fire when a pressure of twenty pounds or more is applied on its pressure cap. The pressure acts on a trigger pin that is forced downward until a striker rod is released. The striker is then driven forward against a percussion cap. The device may be used for initiating booby traps and improvised mines, and as a fuse lighter.

Comments: This device was tested. It is effective.

Reference: TM 9-1900, Ammunition, General, page 274.

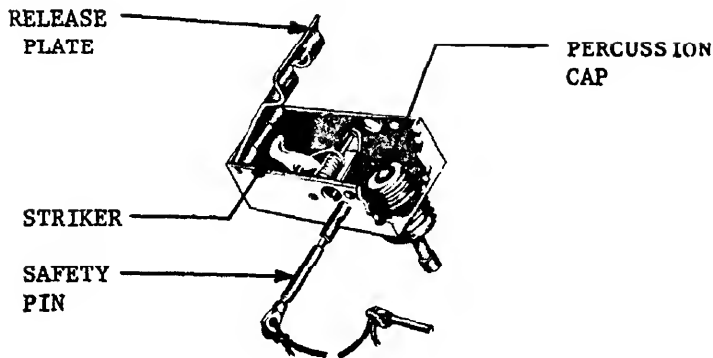

Description: This fuze is designed to fire when a restraining load of five pounds is displaced. A release plate is actuated and releases a striker that is driven against a percussion cap, thus initiating the charge. This device may be used for initiating booby traps, as a fuze lighter, and as a lanyard-operated firing system.

Comments: This device was tested. It is effective.

Reference: FM 5-31, Boobytraps, page 57.

PULL FUZE, M1

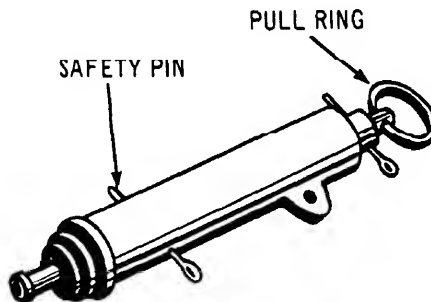

Description: The item shown is a mechanical pull fuze. A 3-5 pound pull on the pull ring cocks a firing spring. On tension release, a spring actuated firing pin is driven into a percussion primer. The cotter pin nearest the pull ring locks the device while the other is a safety pin

between firing pin and primer. The fuze may be used for initiating boobytraps, as a lanyard firing device, or for a fuze lighter.

Comments: This item was tested. It is effective.

Reference: TM 9-1900, Ammunition, General, pages 253 and 254.

DELAY FUZE, M1

24-5

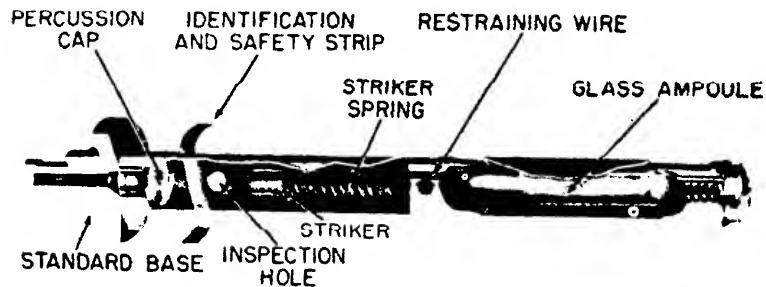

Description: This delay fuze, also called time pencil, is a percussion type, chemically operated firing device. It has a delay time from 2 minutes to 23 days, depending on the model and prevailing temperatures. The device consists of a thin metal tube containing a spring-loaded firing pin that is held cocked by a restraining wire, and a glass ampoule filled with a corrosive solution. When the ampoule is crushed by an arming screw, the corrosive solution dissolves a portion of the restraining wire, releasing the striker. The striker drives forward hitting the percussion cap that initiates an explosive charge. A colored identification and safety strip fits through the sides of the tube and prevents premature firing.

Comments: This item was tested. It is effective. The time delay of this device is not exact. Therefore, it should not be used if accuracy is needed.

References: FM 5-25, Explosive and Demolitions, page 33.

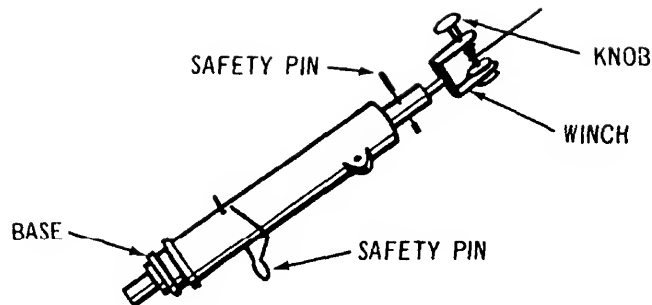

Description: This fuze is designed to function when an adjusted spring tension is either increased (pull) or decreased (release). A pull of from six to ten pounds or a slight relaxation of tension will allow a striker to initiate a percussion cap. This device may be used for initiating boobytraps.

Comments: This device was tested. It is effective.

Reference: FM 5-31, Boobytraps, page 54.

FLN IMPROVISED FUZE

24-7

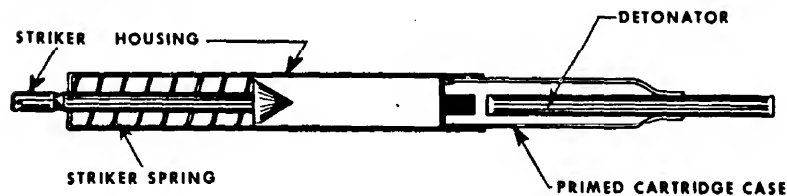

Description: This device was improvised in Algeria by FLN personnel. It consists of a housing made from a piece of thin walled tubing (whose end has been closed by hammering it over a mandrel), a striker (made from a piece of steel), a steel spring, a detonator, and a primed cartridge case. Upon release, the striker hits the primer which in turn initiates the detonator.

Comments: The test history of this item is not known. The device is presumed to be effective.

Reference: (C) FSTC 381-5012, Typical Foreign Unconventional Warfare Weapons (U), Army Materiel Command, Sep 1964, page 22.

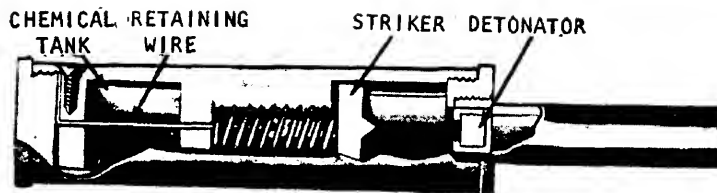

Description: This fuze is constructed of brown or transparent plastic. It is one inch in diameter and is $5\frac{7}{8}$ inches long. Actual use of the fuze is not known. It is believed that a small hole is drilled in an explosive to accept the booster end of the fuze. A spring-loaded striker is retained by a thin wire that is held by an anchor block. The brown opaque model uses an 0.035 inch diameter retaining wire, while an 0.042 inch diameter retaining wire is used in the transparent model. A small bottle containing cupric chloride is included with the device. The cupric chloride is poured into the chemical tank. The resulting chemical action between the cupric chloride and the retaining wire weakens the wire causing it to snap and release the striker to fire a detonator.

Comments: The test history of this item is not verified. The device is presumed to be effective. It was reported in the reference that tests were conducted with the transparent unit and the following delay times were noted: tank $\frac{1}{4}$ full—63 minute delay; tank $\frac{3}{4}$ full—53 minute delay; tank full—45 minute delay. The brown unit should give correspondingly shorter delay times because it has a smaller diameter retaining wire.

Reference: TM 9-1985-4, Japanese Explosive Ordnance, page 256.

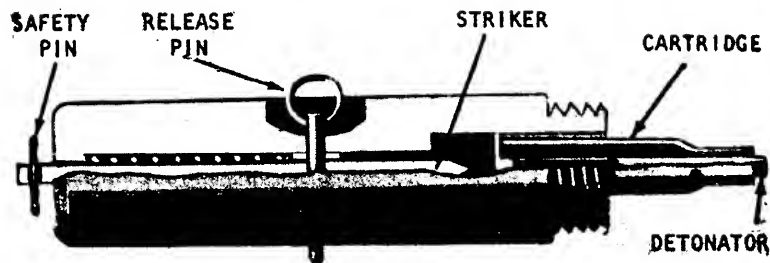

Description: This device was designed to fit the fuze cavity of a British 20-pound bomb but it is easily adapted for use with boobytraps. It consists of a black, cast-iron body $5\frac{3}{8}$ inches long by $1\frac{1}{2}$ inches in diameter. It weighs 2 pounds, 6 ounces. The body houses a spring-loaded striker that is held in position by a safety pin and a release pin. The explosive train consists of a 6.5mm primed cartridge case with the propellant removed. A blasting cap is wedged into the empty cartridge case with the open end facing the cartridge primer. In use, a trip wire is attached to the ring of the release pin, and the safety pin is removed. A pull on the trip wire removes the release pin which frees the striker. The striker hits the cartridge primer, initiating the detonator and exploding the bomb or an explosive charge.

Comments: The test history of this item is not known. The device is presumed to be effective.

Reference: TM 9-1985-4, Japanese Explosive Ordnance, page 250.

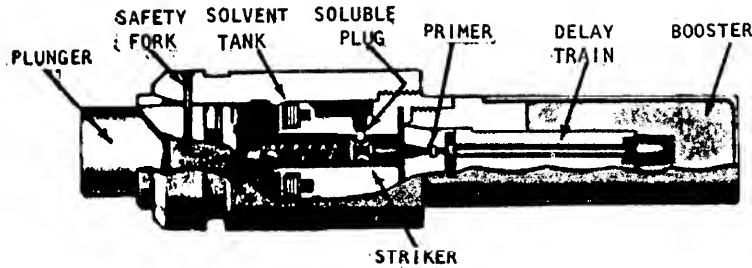

Description: This Delay Fuze was used for sabotage and demolition work. It is made of black bakelite and is 10 inches long by 2½ inches in diameter. To operate the device the safety fork is removed and the plunger depressed. This action causes two spikes on the plunger to pierce a solvent tank and release the solvent. The solvent softens a soluble plug that allows a striker detent to cam outward and free the striker. The delay time of this device is not known because a solvent tank was not recovered. The lower section houses the primer, pressed black powder delay train, a booster from a 22mm projectile fuze, and a tetryl booster. The black powder delay is six seconds.

Comments: The test history of this item is not known. The device is presumed to be effective.

Reference: TM 9-1985-4, Japanese Explosive Ordnance, page 257.

BRITISH DELAY IGNITER, MK I

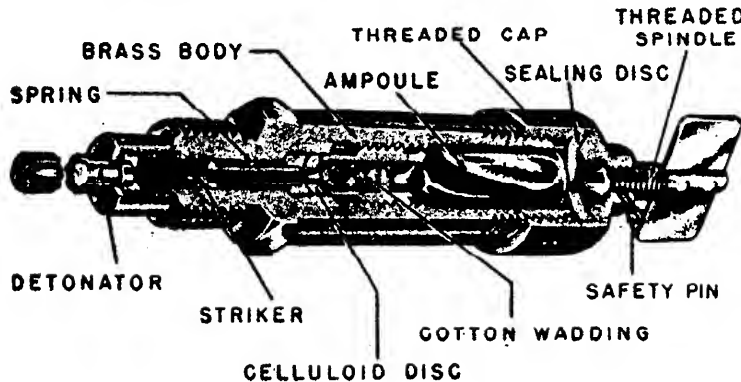

Description: The Delay Igniter MK I is a chemically operated long-delay device. The spring loaded striker is restrained by a celluloid disk. When actuated, an ampoule of acetone is crushed, which allows the solvent to saturate cotton wadding directly above the celluloid disk. Eventually the disk is sufficiently softened to release the spring-loaded striker. The striker is then driven into the detonator. Delay times can be varied by changing the solvent ampoule. Six different delays are available, each indicated by a color.

Comments: The test history of this item is not known. The device appears to be effective. Delay times are calibrated at 20° C. and will vary above and below that point.

Reference: (C) TM 9-1985-1, British Explosive Ordnance (U), page 449.

GERMAN PRESSURE FUZE

24-12

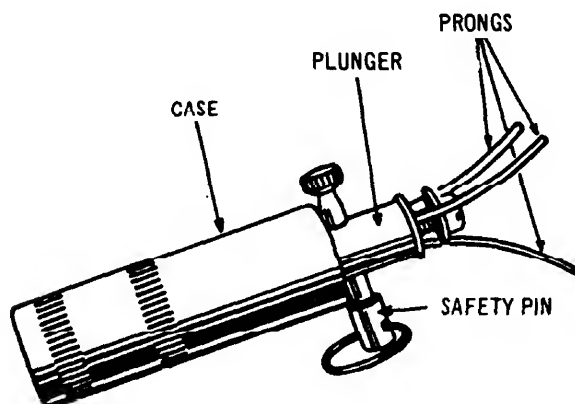

Description: Pressure Fuze S.Mi.Z.35 is designed to function when a pressure of 8-10 pounds is applied on prongs projecting from a plunger. Locking balls are released when the plunger is depressed and this action frees a striker that is driven against a percussion cap. This device may be used for initiating boobytraps and improvised mines and as a fuze lighter.

Comments: The test history of this item is not known. The device appears to be effective.

Reference: TM 9-1985-2, German Explosive Ordnance, page 299.

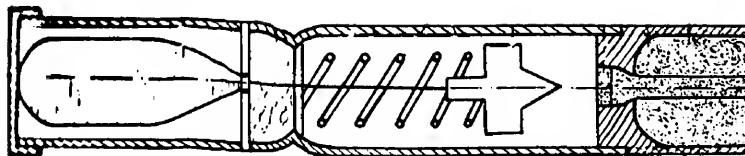

Description: This fuze is employed to set off mines and TNT demolition blocks. It is 8 inches long and operates as follows: The tube at the left contains a solution of copper sulfate. When it is broken, the solution soaks cotton in a container that surrounds a release wire. The resulting chemical reaction erodes the release wire. The spring forces the firing pin against the primer. The primer detonates a fuze having a tetryl charge. Delay is between 20 and 38 minutes.

Comments: The test history of this item is not known. The device appears to be effective.

Reference: Report EODS-65-3, Viet Cong's Explosive Ordnance Used in South Vietnam, U. S. Naval School, Explosive Ordnance Disposal, Jul 1965, page 69.

Section 25. FIRING DEVICES

FUSE LIGHTER, M2

25-1

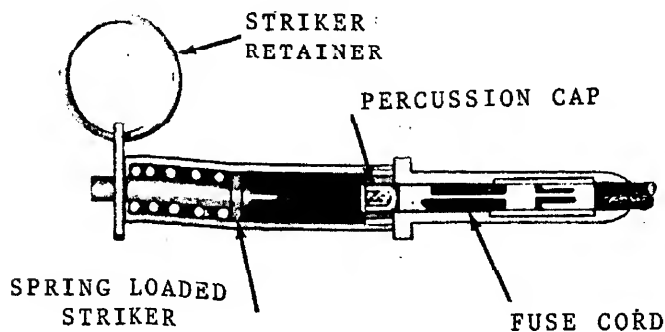

Description: This device was designed as a positive method of lighting a time fuse or Safety Fuse M700. It operates effectively under all weather conditions, and even under water if properly waterproofed. A pull on the striker retaining pin releases the spring loaded striker that

is driven into the percussion cap, igniting the fuse. A sealing compound is used to waterproof the joint between fuse and lighter. To fire, the barrel is held with one hand and the release pin is pulled with the other hand.

Comments: This item was tested. It is effective.

Reference: FM 5-25, Explosives and Demolitions, page 20.

FUSE LIGHTER, M60

25-2

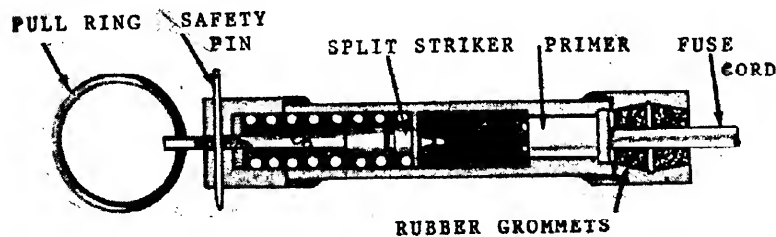

Description: This device was designed to ignite a time fuse or Safety Fuse M700 in all weather conditions and under water. Fuse cord is inserted into the fuse retainer and sealed by means of two rubber grommets. A pull on the pull ring releases the spring loaded striker, allowing the firing pin to drive against the primer and ignite the fuse cord. To fire, the safety pin is removed and the barrel is held in one hand while the pull ring is pulled with the other hand.

Comments: This item was tested. It is effective. The fuse lighter is reusable after reassembly of parts and insertion of a new primer.

Reference: FM 5-25, Explosives and Demolitions, page 20.

WATCH DELAY FIRING DEVICE

25-3

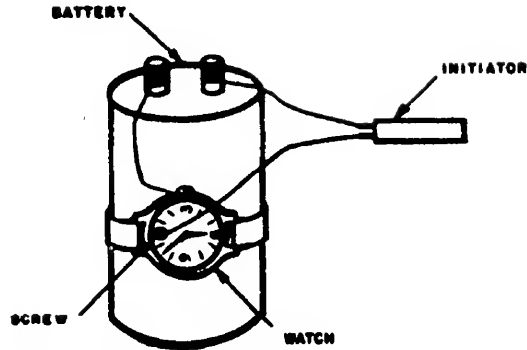

Description: This device is constructed from an initiator, a battery, a small screw, and a watch having a plastic crystal. The crystal is drilled or pierced with a heated nail. The screw is inserted in the hole and wires are attached to the screw, watch case, initiator, and battery. When the watch hand makes contact with the screw, an electric circuit is completed causing the initiator to fire. If the watch has a sweep or large second hand, it is removed. If a delay time of more than one hour is required, the minute hand is also removed.

Comments: This item was tested. It is effective.

Reference: TM 31-210, Improvised Munitions, sec VI, No. 4.

BRITISH DELAY FIRING DEVICE NO. 9

25-4

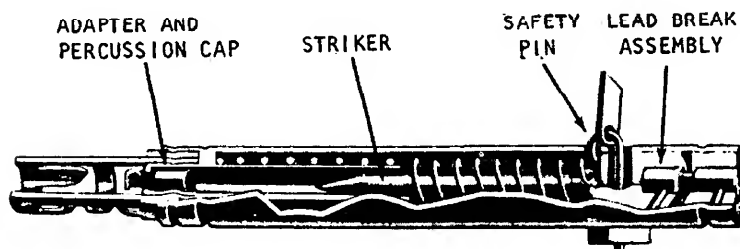

Description: The firing device No. 9, MK I is designed to actuate a demolition charge by delayed action. This time delay utilizes the creep properties of tellurium-lead. Tellurium-lead stretches and eventually breaks when subjected to a small tensile stress. The device consists of

a metal tube $4\frac{3}{8}$ inches long that houses a striker, spring, and lead-break assembly. An adapter with percussion cap is crimped into the base of the device. When the safety pin is removed, the spring force acts on the lead-break assembly that eventually fails (breaks). The spring then drives the striker against the percussion cap to detonate an explosive charge. These devices are issued with 10 different delay times. The delay time (at 65° F.) is indicated on the tag attached to the safety pin.

Comments: The test history of this item is not known. The device is presumed to be effective.

Reference: (C) TM 9-1985-1, British Explosive Ordnance (U), page 430.

BRITISH ANTIPERSONNEL FIRING DEVICE NO. 8

25-5

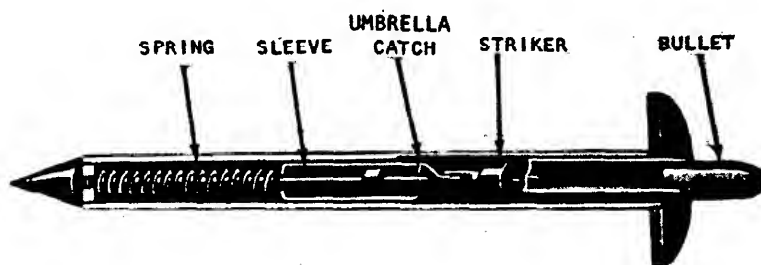

Description: The antipersonnel firing device No. 8, MK I is a self-contained unit that is sunk into roads and pathways. It is initiated by pressure and discharges a bullet that will pierce a man's foot or severely damage a pneumatic tire. The device consists of a metal spike that is pressed into the ground or carefully hammered into a road. Slight pressure on top of the bullet forces the hollow shaft of the striker over an umbrella catch, releasing the sleeve that holds a spring in compression. The spring drives the sleeve upwards against the striker head and fires the cartridge.

Comments: The test history of this item is not known. The device is presumed to be effective.

Reference: (C) TM 9-1985-1, British Explosive Ordnance (U), page 429.

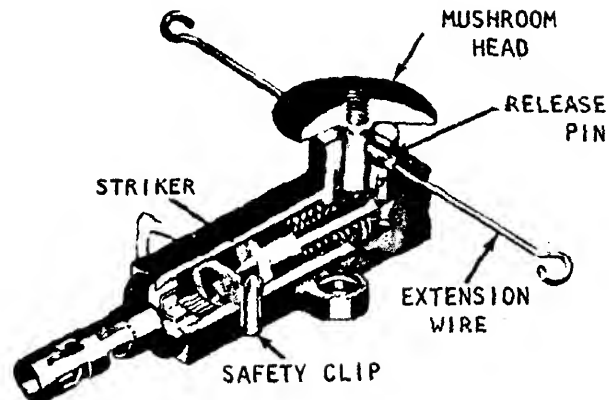

Description: This device is designed for use in boobytraps where either pull, pressure, or release of pressure is desired for initiation. It may also be used to initiate demolition charges and is suitable for use under railroad tracks, crates, etc. It is unaffected by water and will function when immersed. The switch is $\frac{1}{2}$ inch wide, 1 inch high and $1 \frac{7}{16}$ inches long. With the release pin in place, a pull of 3 pounds on the extension wire or a load of 33 to 50 pounds on the mushroom head will actuate the device. With the release pin removed and a 2 pound load on the mushroom head, it is set for release operation and will detonate when the load is removed.

Comments: The test history of this item is not known. The device is presumed to be effective.

Reference: (C) TM 9-1985-1, British Explosive Ordnance (U), page 435.

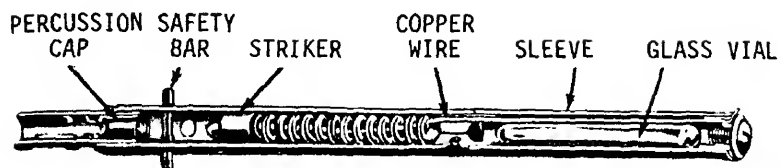

Description: The firing device No. 10, MK I is used in sabotage and demolition work and is designed to initiate an explosive charge by delayed action. It is 5 inches long and 5/16 inch in diameter. When the copper sleeve is crushed and the glass vial broken, a corrosive liquid is released to attack a copper wire that retains a spring-loaded striker. When this wire is eaten through, the striker spring drives the striker into the percussion cap. Delay times are indicated by the color of the safety bar. Five delay times are available but vary widely depending on ambient temperatures.

Comment: The test history of this item is not known. The device is presumed to be effective. It is recommended that two time pencils be used for each charge to reduce risk of failure.

Reference: (C) TM 9-1985-1, British Explosive Ordnance (U), page 431.

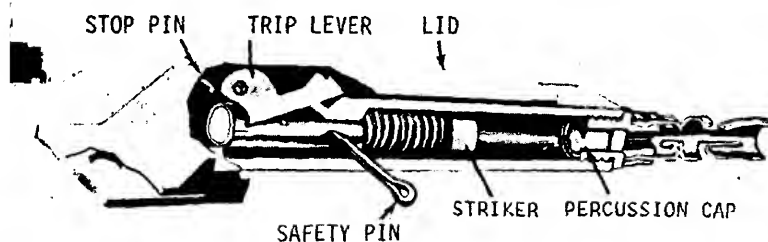

Description: The firing device No. 6, MK I is designed for use in boobytraps where initiation by release of pressure is desired. It is thin

so that it can be inserted into narrow openings, such as under a door or behind a drawer. It will withstand the weight of heavy objects, such as packing cases. When the lid is seated firmly, a trip lever engages a notch in the striker and holds it back against spring pressure. A stop pin limits upward movement of the trip lever. After the safety pin is withdrawn and a restraining load is removed from the lid, the pressure on the trip lever forces the lid upwards, allowing the lever to swing counterclockwise and disengage from the striker. The striker spring then drives the striker into the percussion cap.

Comments: The test history of this item is not known. The device is presumed to be effective.

Reference: (C) TM 9-1985-1, British Explosive Ordnance (U), page 426.

BRITISH PRESSURE FIRING DEVICE NO. 5

25-9

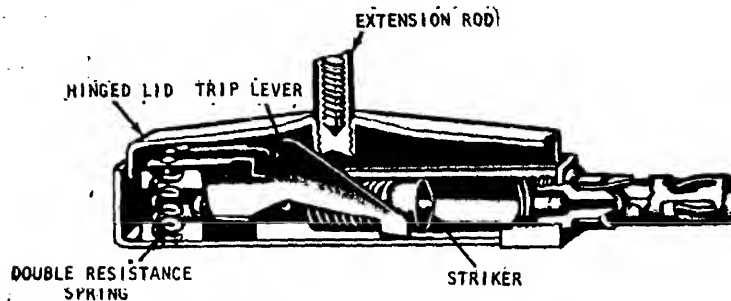

Description: The firing device No. 5, MK I is designed to be used in boobytraps where pressure initiation is required. An adjustable extension rod makes it easy to place the device under such objects as railroad tracks. It is $3\frac{3}{4}$ inches long, $\frac{3}{4}$ inches high, and $1\frac{1}{4}$ inches wide. The mechanism consists of a body covered by a hinged lid. The trip lever is held in the raised position, engaging the striker, by a double resistance spring. A pressure of 50 to 60 pounds at the hinge end or 21 pounds at the opposite end will depress the trip lever and disengage it from the striker. The striker is then driven by spring pressure into a percussion cap.

Comments: The test history of this item is not known. The device is presumed to be effective.

Reference: (C) TM 9-1985-1, British Explosive Ordnance (U), page 425.

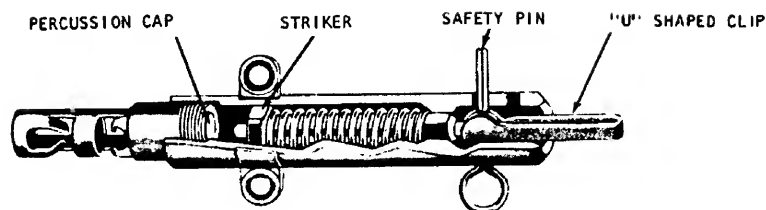

Description: The firing device No. 4, MK I is intended primarily for use with a trip wire to fire boobytraps. It may also be used to fire mines, flares, and demolition charges. It is made of brass and painted olive drab. It is $3\frac{3}{4}$ inches long and $\frac{7}{8}$ inches in diameter. A U-shaped clip grips the rounded end of the striker, holding it in the cocked position. A safety pin passes through the housing tube and the rounded striker head. With the safety pin removed, a pull of 6 to 8 pounds on a trip wire, attached to the U-shaped clip, will withdraw the clip and release the striker. The striker is then driven by spring pressure into a percussion cap.

Comments: The test history of this item is not known. The device is presumed to be effective.

Reference: (C) TM 9-1985-1, British Explosive Ordnance (U), page 423.

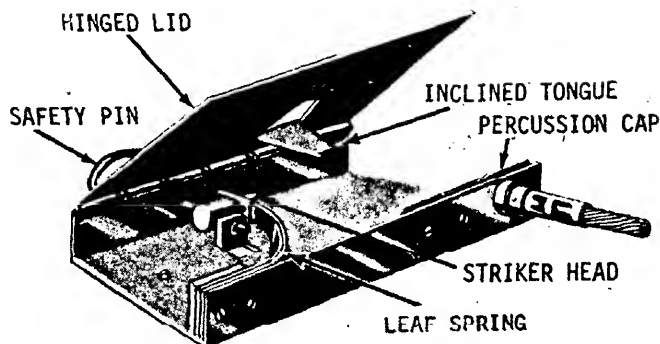

Description: The firing device No. 3, MK I is designed for use in boobytraps where initiation by release of pressure is required. It is placed under crates, packages, books, or other suitable objects. Although rarely used as such, the device may also be employed to initiate demolition charges. The body of the device consists of a shallow channel section with open ends and a hinged cover with an inclined tongue. A safety pin passes through the body, the striker head, and a brass block attached to the body. When pressure is removed from the hinged lid, the pressure of the leaf spring on the inclined tongue forces the lid upwards. The striker is then driven by spring pressure into the percussion cap.

Comments: The test history of the item is not known. The device is presumed to be effective.

Reference: (C) TM 9-1985-1, British Explosive Ordnance (U), page 422.

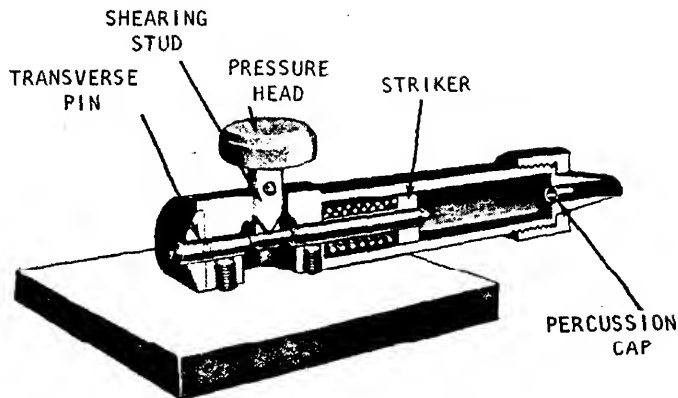

Description: The firing device No. 2 (MK I and II) is designed for use in boobytraps where initiation by pressure is desired. It is used under boards, doormats, etc. The device may also be used to initiate demolition charges. It is $4\frac{5}{8}$ inches long, $1\frac{1}{2}$ inches wide, and $1\frac{1}{2}$ inches high when armed. It consists of a tube mounted on a rectangular base plate. A spring-loaded striker is located inside the tube and secured at one end by a transverse pin. A flat, disk-shaped pressure head is located on top of the shearing stud. A pressure of 30 to 40 pounds on the pressure head will cause the V-shaped cutting edge of the shear stud to break the striker spindle. The striker is then driven forward by the spring into the percussion cap. The principal difference between the MK I and MK II devices is that base plate and tube are cast as one piece in the MK II.

Comments: The test history of this item is not known. The device is presumed to be effective.

Reference: (C) TM 9-1985-1, British Explosive Ordnance (U), page 421.

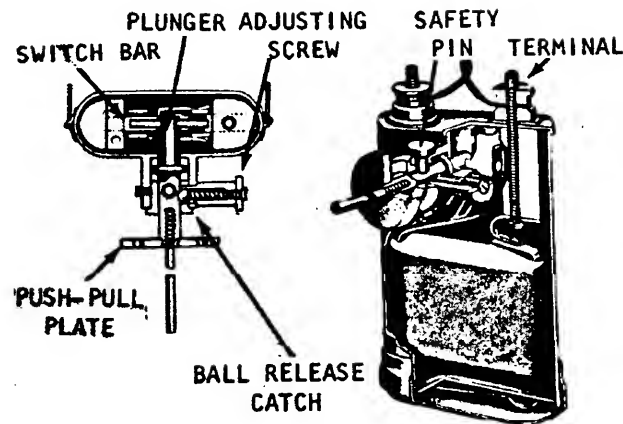

Description: The firing device No. 7, MK I is used for initiating booby-traps by either push or pull. An electric firing cable connects to two terminals on top of the unit. The push-pull mechanism consists of a plunger, an external push-pull plate, and an internal switch bar that completes the electric circuit when the plunger is moved. Actuating pressure can be adjusted from 5 up to 35 pounds. With the safety pin removed, pull or pressure on the plate overcomes the pressure of the ball release catch, moving the switch bar and completing the circuit.

Comments: The test history of this item is not known. The device is presumed to be effective.

Reference: (C) TM 9-1985-1, British Explosive Ordnance (U), page 427.

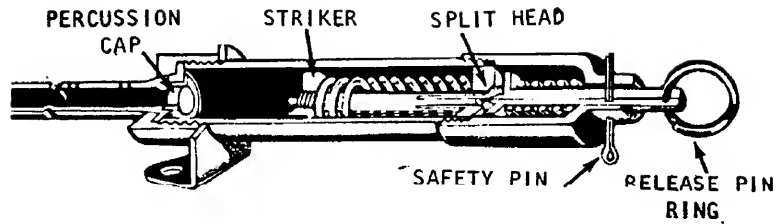

Description: The firing device No. 1, MK I is used to initiate booby-traps or demolition charges. It is designed to operate when a direct pull is exerted on a trip wire attached to the release pin. The device is 4 inches long and $\frac{5}{8}$ inches in diameter. It weighs $2\frac{3}{4}$ ounces. A pull of two pounds on the trip wire attached to the pull ring removes the release pin from the split head of the striker, that contracts sufficiently to pass through the split head. The striker spring then drives the striker into the percussion cap.

Comments: The test history of this item is not known. The device is presumed to be effective.

Reference: (C) TM 9-1985-1, British Explosive Ordnance (U), page 420.

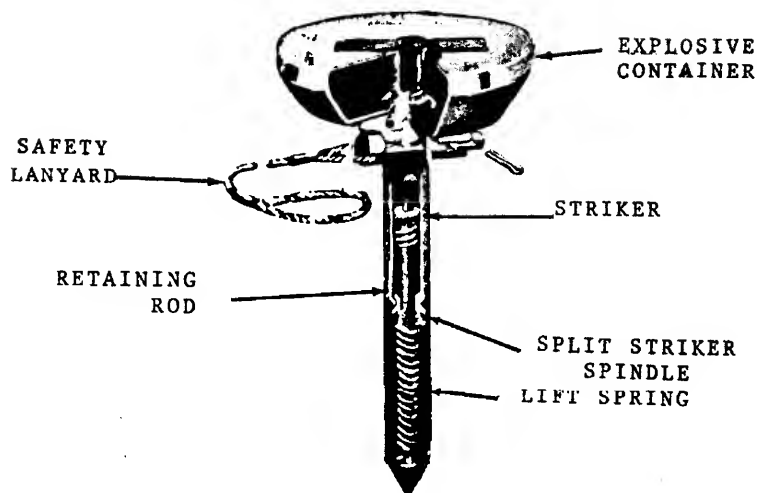

Description: The firing device No. 12, MK I is employed as an antilift device. It is ideal to prevent removal of land mines. The device consists of a shallow, tapered explosive container and a short tube that contains the striker release mechanism. A lift spring tends to force the explosive container up and the release mechanism out of the tube unless prevented by a sufficient weight (minimum 2 pounds) resting on top of the explosive container. When the weight is removed, the lift spring forces the release mechanism tube upwards, disengaging the retaining rod from the split striker spindle, allowing the striker to fire a detonator.

Comments: The test history of this item is not known. The device is presumed to be effective.

Reference: (C) TM 9-1985-1, British Explosive Ordnance (U), page 434.

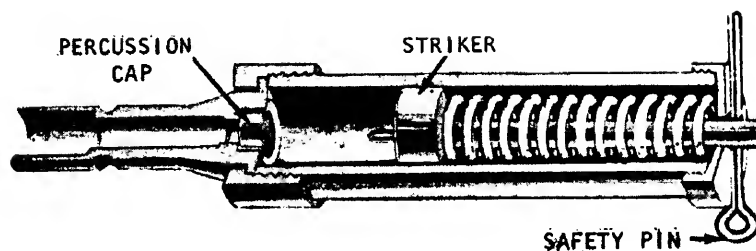

Description: This is a manually operated device for initiating demolition charges. Operated by a trap wire, it may also be used to initiate improvised boobytraps and mines. The device will ignite safety fuse detonators that may be inserted into an adapter at the percussion cap end of the tube. A minimum pull of $2\frac{1}{4}$ pounds on a trip wire will remove the safety pin from the striker. The released striker will then be driven by the spring into the percussion cap, firing a fuse or detonator.

Comments: The test history of this item is not known. The device is presumed to be effective. It is now obsolete.

Reference: (C) TM 9-1985-1, British Explosive Ordnance (U), page 439.

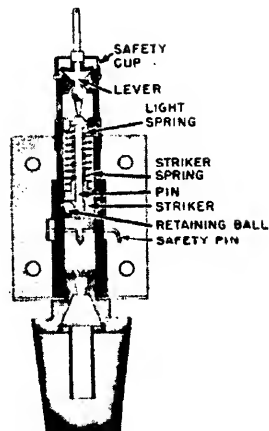

Description: This is a sensitive device actuated by a very light pull from any direction. Trip wires can be attached to the actuating lever. With the safety pin removed, a pull on any trip wire attached to the trip lever will pivot the lever from the top of the retaining pin, that is then forced out of the striker by its spring. The retaining balls are then allowed to move inward, releasing the striker and firing a percussion cap that in turn sets off a detonator.

Comments: The test history of this item is not known. The device is presumed to be effective. It is now obsolete.

Reference: (C) TM 9-1985-1, British Explosive Ordnance (U), page 441.

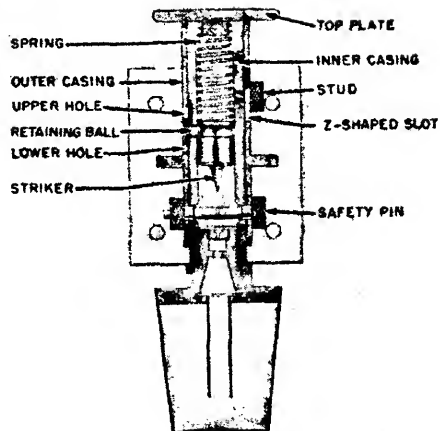

Description: This device was used in boobytrap installations for initiating explosives and incendiaries. It may be used for pressure, release of pressure, or pull operation. A setting stud on the side of the device rides in a Z-shaped groove. The position of this stud in the groove determines the type of operation to be used. Operation is similar in all three positions. The top plate moves either up or down to allow the retaining ball to slip out of the groove in the striker. This releases the striker that is driven by the spring into a percussion cap.

Comments: The test history of this item is not known. The device is presumed to be effective. It is now obsolete.

Reference: (C) TM 9-1985-1, British Explosive Ordnance (U), page 441.

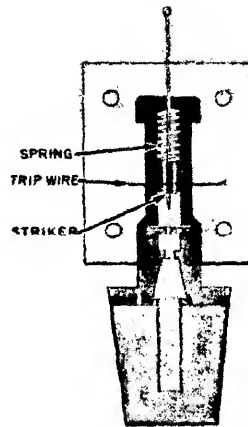

Description: This is a very simple device designed to initiate explosive charges. It is operated by a direct pull on a trip wire. It consists of a spring-loaded striker restrained by a special 2-foot long wire. A pull on this wire releases the striker that fires a percussion cap. If a longer wire is desired, standard trip wire may be spliced to the free end of the special wire.

Comments: The test history of this item is not known. The device is presumed to be effective. It is now obsolete.

Reference: (C) TM 9-1985-1, British Explosive Ordnance (U), page 241.

JAPANESE PULL IGNITER

25-20

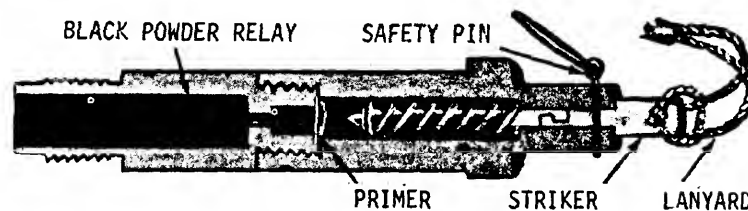

Description: This igniter is used as a pull firing device for boobytraps. It is made of steel, is $\frac{1}{2}$ inch in diameter and 3 inches long. The body is made in two sections. The front section contains a primer cap and a

black powder relay. The rear section houses the firing assembly which is composed of a two-piece striker, spring, safety pin, and lanyard. After removal of the safety pin, a pull on the lanyard draws the striker to the rear and compresses the spring. When the notched joint of the striker clears the end of the striker body, the forward section of the striker disengages and is driven by the spring into the primer cap.

Comments: The test history of this item is not known. The device is presumed to be effective.

Reference: TM 9-1985-4, Japanese Explosive Ordnance, page 247.

FLN WHEEL-FLANGE FIRING DEVICE

25-21

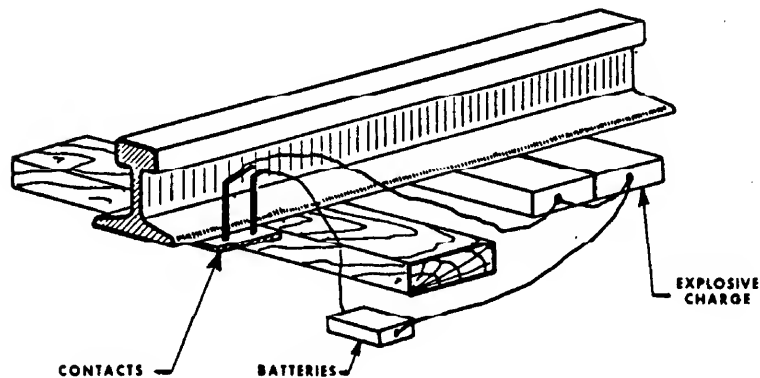

Description: The Algerian device shown above consists of a board with two flexible electric contacts attached to it. It is laid on the inside of a rail so that the flange of the locomotive wheel can bring the contacts together and close the circuit through an electric detonator. This device is sturdy and resistant to displacement by shock but, because it is placed above ground, it can be detected easily, even when camouflaged with a small bush or leaves.

Comments: The test history of this item is not known. The device appears to be workable.

Reference: (C) FSTC 381-5012, Typical Foreign Unconventional Warfare Weapons (U), Army Materiel Command, Sep 1964, page 27.

Section 26. FIRING SWITCHES

METAL BALL SWITCH

26-1

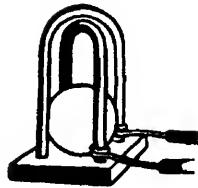

Description: This device is an electrical switch that operates when it is tipped in any direction. It can be used for boobytraps and, in conjunction with another switch or timer, as an antisturbance device. It is constructed of a metal ball, solid copper wire, a wooden block, and electrical connecting wires. The solid copper wires are bent into U-shapes and inserted into holes in the wood block base. The two U-shaped wires thus form a cage inside which the metal ball is placed. The ball is centered within the cage by means of a hole in the wooden base. Connecting wires are attached to the legs of the U-shaped wires and then connected to an electric power source and firing system. When the switch is tipped in any direction the metal ball comes into contact with the legs, closing the electrical circuit.

Comments: This device has been tested. It is effective.

Reference: TM 31-210 Improvised Munitions, sec VII, No. 4.

ALTIMETER SWITCH

26-2

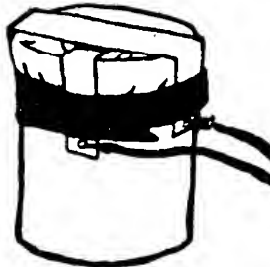

Description: This device is designed for use with explosive charges placed on aircraft. It operates due to air pressure differential between ground level and 5000 feet altitude. The device is constructed of a wide mouth jar over which is placed a thin sheet of plastic or wax paper securely taped to the jar. Electrical contacts are made of thin metal sheet and a connecting wire is attached to each contact. The contacts

are then fastened to the jar with tape so that a small clearance is maintained between the contacts. The device is connected in an explosive circuit and the assembled package placed on an aircraft. As the aircraft rises, the air inside the jar expands forcing the plastic sheet against the contacts and closing the firing circuit.

Comments: This device has been tested. It is effective.

Reference: TM 31-210, Improvised Munitions, sec VII, No. 5.

GERMAN WIRE-COIL SWITCH

26-3



Description: This switch is made from two lengths of insulated wire. The insulation has been stripped from one end of one wire for a distance of about 3 inches, and this bare end is formed into a coil. About one inch of insulation is stripped from the same end of the other wire, and this bare end is placed inside the coil so that the two bare sections do not touch. The coil is laid on top of a railroad track and, when crushed by a passing wheel, completes an electric circuit to fire an electric detonator.

Comments: The test history of this item is not known. The device appears to be workable.

Reference: (C) FSTC 381-5012, Typical Foreign Unconventional Warfare Weapons (U), Army Materiel Command, Sep 1964, pages 27 and 28.

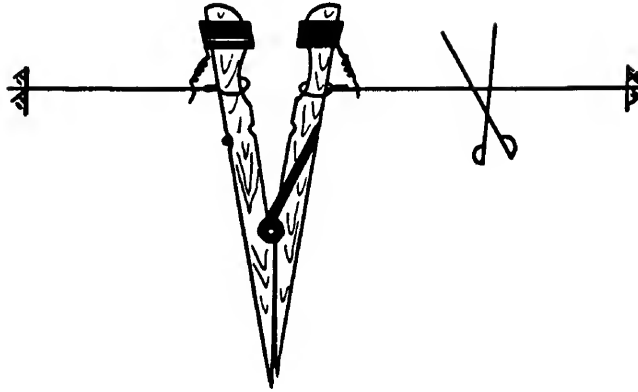

Description: This device consists of a clothespin whose jaws are held open by trip wires. When the trip wires are cut or broken, the spring action of the clothespin brings together two metal contacts and completes an electric circuit to fire a detonator. In addition to being used by the Algerian FLN, this type of device was also used by Soviet troops during World War II.

Comments: This item was tested. It is effective.

References: (C) FSTC 381-5012, Typical Foreign Unconventional Warfare Weapons (U), Army Materiel Command, Sep 1964, pages 25 and 26.

TM 31-210, Improvised Munitions, see VII, No. 1.

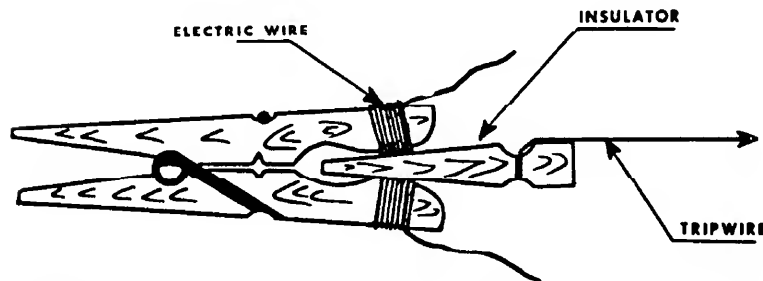

Description: This device consists of a clothespin, two metal contacts, an insulator, and a trip wire. A pull on the trip wire will dislodge the insulator from between the jaws of the clothespin, and the spring action

of the clothespin will bring the two metal contacts together to complete an electric circuit. For disarming, the trip wire may be cut (because it is slack) and the insulator will remain in place because of the gripping action of the clothespin jaws.

Comments: This item was tested. It is effective.

References: (C) FSTC 381-5012, Typical Foreign Unconventional Warfare Weapons (U), Army Materiel Command, Sep 1964, pages 24 and 25.

TM 31-210, Improvised Munitions, sec VII, No. 1.

GERMAN CAN DELAY SWITCH

26-6

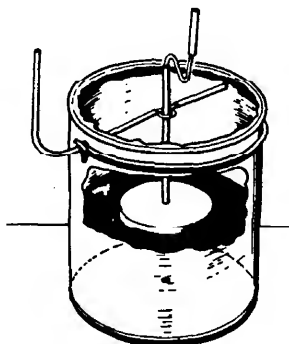

Description: This device consists of a tin can with a small hole in the bottom and two insulated wires that lead to a detonator circuit. The insulation is stripped from a portion of one wire, and this bare section is formed into a loop. The second wire also has a bare section that is formed into a zigzag shape. The insulated portion of the second wire is passed through the loop of the first wire. The end of the second wire is fixed to a cork and the can is filled with water. When the water level drops sufficiently, the bare zigzag portion of the second wire makes contact with the bare section of the looped wire to complete an electric circuit.

Comments: The test history of this item is not known. The device appears to be workable.

Reference: (C) FSTC 381-5012, Typical Foreign Unconventional Warfare Weapons (U), Army Materiel Command, Sep 1964, pages 29 and 30.

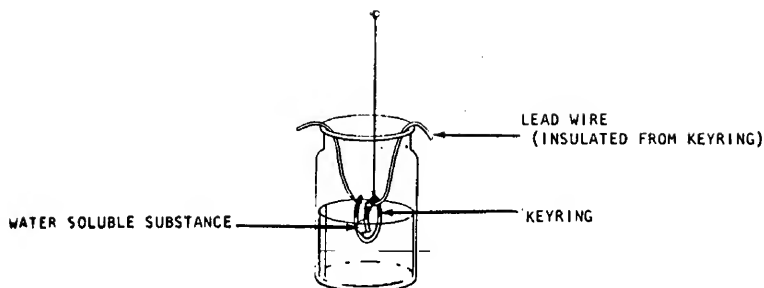

Description: The German key ring delay consists of a spring-type key ring having its coils held apart by a small water-soluble substance such as a lump of sugar or a salt tablet. Two lead wires are connected to the adjacent coils with one wire insulated from its coil. The assembly is then suspended from a hook or nail, and a glass is placed around it. Water is then added to the glass to cover the soluble lump but not the bare ends of the wires. The water gradually dissolves the lump and the coils resume their original position, bringing together the two bare wires to complete an electric circuit.

Comments: The test history of this item is not known. The device appears to be workable.

Reference: (C) FSTC 381-5012, Typical Foreign Unconventional Warfare Weapons (U), Army Materiel Command, Sep 1964 page 31.

FLEXIBLE PLATE SWITCH

26-8

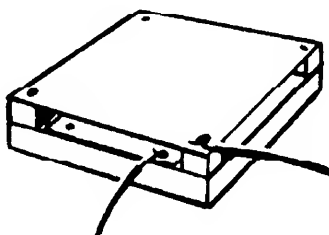

Description: This device is a pressure sensitive electric switch used for initiating emplaced mines and explosives. It is constructed of two flexible metal sheets, a wooden base, four wooden blocks, nails, copper wire, and adhesive tape. One metal plate is nailed to the base and a length of wire is attached to one of the nails. The other metal plate is supported on the wood blocks, and the plate and blocks are nailed to

the base. A length of wire is attached to this top plate by one of the nails. The wires are then connected to a battery and explosive system. Adhesive tape (not shown in the sketch) is wrapped around the sides of the switch to prevent dirt or other matter from interfering with its operation. When the device is emplaced in a roadway and a vehicle passes over it, the metal plates make contact, closing the electrical circuit and firing the explosive.

Comments: This device was tested. It is effective.

Reference: TM 31-210, Improvised Munitions, sec VII, No. 3.

DRIED SEED DELAY SWITCH

26-9

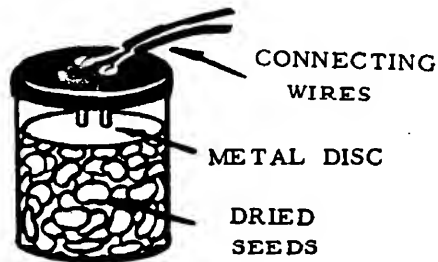

Description: A time delay device for electrical firing circuits can be made using the principle of expansion of dried seeds. The device is constructed from a wide mouth glass jar with a nonmetal cap, two screws, and a thin metal plate. Holes are drilled in the cap to receive the two screws. Two wires, leading to a battery and blasting cap, are attached to the screws. Dried beans, peas, or other dchhydrated seeds are placed in the jar and the metal plate is set on top of the seeds. Water is added to cover the seeds and the cap is placed on the jar. As the water is absorbed, the seeds expand and raise the metal plate until it contacts the screws and closes the electrical circuit.

Comments: This device was tested. It is workable. Tests must be conducted with a sample of the seeds to determine the delay time of the device.

Reference: TM 31-210, Improvised Munitions, sec VI, No. 6.

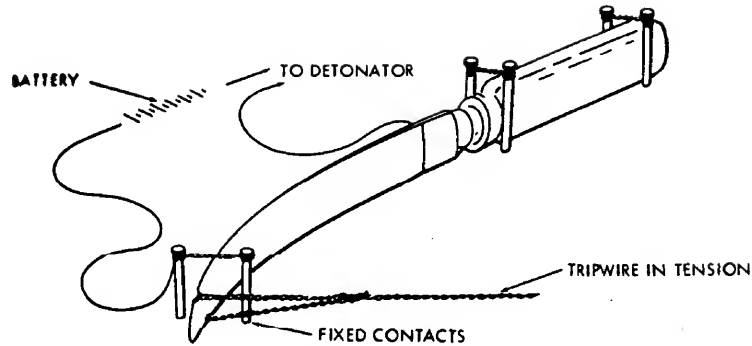
BRITISH KNIFE SWITCH**26-10**

Description: This device operates by application or release of tension on a trip wire. Two pairs of nails hold a knife securely by the handle. A trip wire, sufficiently taut to deflect the blade, is tied to the tip of the knife blade. Electric contact poles, consisting of a pair of nails, are placed near the point of the knife. When the trip wire is pulled, the blade deflects further and contacts the near pole; when the trip wire is cut or broken, the blade contacts the far pole. When contact is made, an electric firing circuit is completed.

Comments: The test history of this item is not known. The device appears to be workable.

Reference: (C) FSTC 381-5012, Typical Foreign Unconventional Warfare Weapons (U), Army Materiel Command, Sep 1964, page 24.

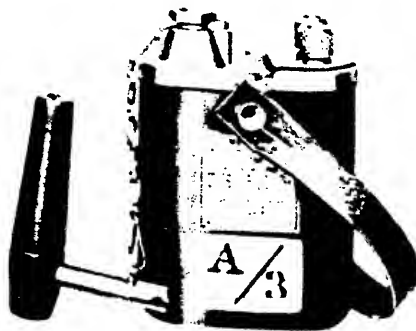
BLASTING MACHINE**26-11**

Description: Blasting machines are used to generate the current necessary to fire explosive charges electrically. There are two types in Army use, the 10 cap twisting-handle type shown above and the 30-50-100 cap push-down handle type. The rated capacity of these devices is based on the number of blasting caps (connected in series) they can be depended upon to fire.

Comments: This item was tested. It is effective.

Reference: TM 9-1900, Ammunition, General, page 279.

GERMAN WATCH SWITCH

26-12

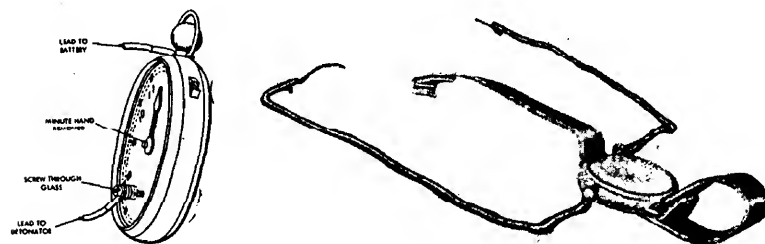

Description: The illustrations show how to rig common watches (pocket or wrist) as time delays. A lead from the battery is connected to the winding stem, and a lead to the electric detonator is connected to a screw through the glass crystal. (The circuit is then completed with a wire from the battery to the other wire from the detonator.) For delays from one to twelve hours, the minute hand is removed. When the hand contacts the screw, the detonator fires.

Comments: The test history of this item is not known. The device is presumed to be effective.

Reference: (C) FSTC 381-5012, Typical Foreign Unconventional Warfare Weapons (U), Army Materiel Command, Sep 1964, pages 32 and 33.

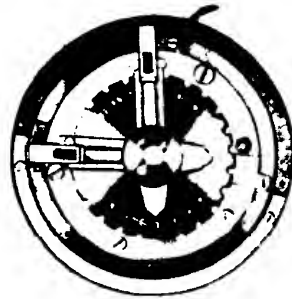

Description: This is a clock specially constructed to close a switch for firing an electrical charge. It incorporates a variable delay in one hour increments up to 24 hours. It has two bridging contact arms that ride on two semicircular electric contacts that can be connected by leads through a battery to an explosive charge. The relation of the two arms to each other governs the amount of the delay. No outer protective case for the working parts of the clock is provided.

Comments: The test history of this item is not known. The device is presumed to be effective.

Reference: TM 9-1985-4, Japanese Explosive Ordnance, page 253.

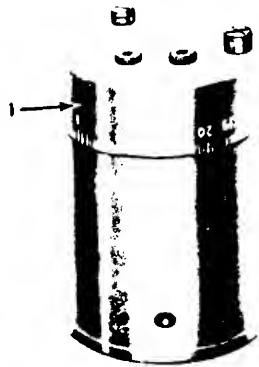

Description: This spring-driven clock may be set for delays up to seven days. It can fire a charge either electrically or mechanically. Electric leads connect the contacts on the clock through a battery to the charge.

A fuze receptacle at the base of the clock is used if the charge is to be fired mechanically. Delay times are set on a graduated ring (1) on the clock base.

Comments: The test history of this item is not known. The device is presumed to be effective.

Reference: TM 9-1985-4, Japanese Explosive Ordnance, page 255.

ITALIAN 50-DAY CLOCK SWITCH

26-15

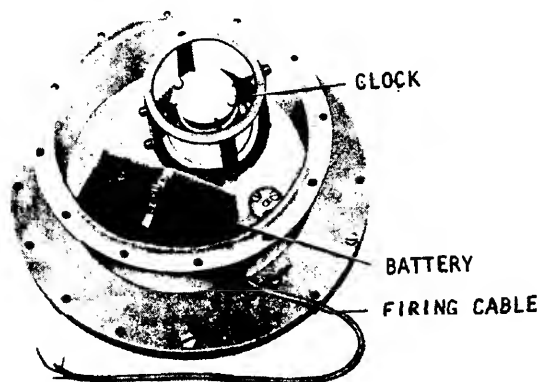

Description: The device shown above is typical of long delay devices (over 2 weeks). They are generally built around a clock mechanism. Although their function is similar to that of a pocket and wrist watch delay, their mechanisms are more complicated because they must count days as well as hours. A housing is generally provided to protect clock and battery.

Comments: The test history of this item is not known. The device is presumed to be effective.

Reference: (C) FSTC 381-5012, Typical Foreign Unconventional Warfare Weapons (U), Army Materiel Command, Sep 1964, page 34.

MOUSETRAP SWITCH

26-16

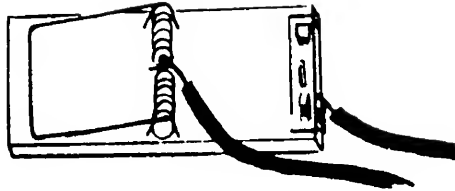

Description: A common mousetrap can be used to make an electric switch for setting off explosive charges, mines, or boobytraps. The trip lever, staple, and holding wire are first removed from the mousetrap. The trip lever is then attached to the opposite end of the trap with the staple. The ends of two lengths of copper wire are stripped of insulation and one wire is tightly wound around the spring-loaded striker of the trap. The other wire is connected to the trip lever. The wires are then connected to a battery and explosive system. This device can be used in several ways. One method is to place switch, battery, and explosive in a box with the lid of the box holding down the spring loaded striker. When the lid is lifted, the striker is released and turns to touch the trip lever, closing the electrical circuit and firing the explosive.

Comments: This device was tested. It is effective.

Reference: TM 31-210, Improvised Munitions, sec VII, No. 4.

JAPANESE LONG DELAY CLOCK

26-17

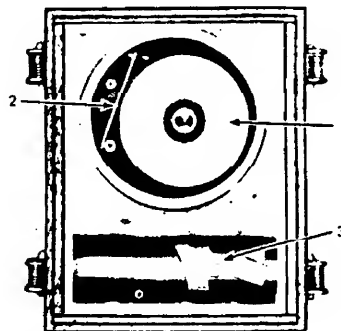

Description: This clock is electrically wound and fires its charge electrically. It has maximum delay time of $10\frac{1}{2}$ days, and winds itself every $4\frac{3}{4}$ minutes. Setting is performed by rotating the graduated dial (1) to the desired delay time. At completion of the delay, a spring-

loaded contact arm (2) drops into an aperture on the outer rim of the dial, and closes the firing circuit. Additional gear trains and setting dials may be provided to extend the delay time to 30 or 60 days. Power for the operation of the clock and firing of the charge is provided by a battery (3) contained in the clock's wooden protective case.

Comments: The test history of this item is not known. The device is presumed to be effective.

Reference: TM 9-1985-4, Japanese Explosive Ordnance, page 253.

JAPANESE SEVEN-DAY PRECISION CLOCK

26-18

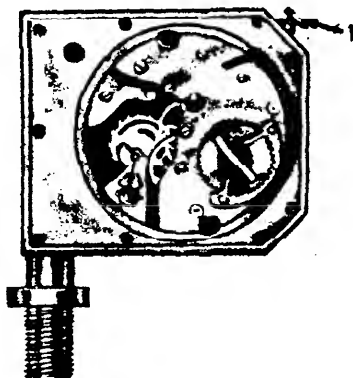

Description: This clock is of European design. It is smaller and more finely made than any of the other Japanese clocks. It is hand-wound with an attached key, and is set by means of a ratchet that bears against the outer edge of the dial. The dial is graduated in one-hour intervals up to 7½ days. The clock fires when a trigger arm falls into an aperture on the circumference of the dial, releasing the spring-loaded striker. The striker aperture is threaded on the inside for a blasting cap and on the outside for a demolition block.

Comments: The test history of this item is not known. The device is presumed to be effective.

Reference: TM 9-1985-4, Japanese Explosive Ordnance, page 255.

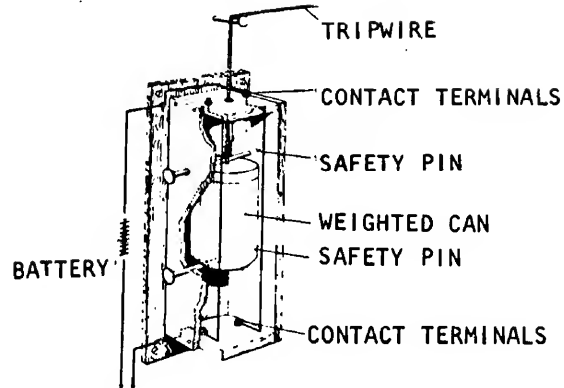

TO ELECTRIC DETONATORS

Description: The device shown above operates either by tension or by tension release. It consists of a wooden box with two contact terminals located at each end. A weighted can is suspended between the two sets of terminals by a trip wire. When either pair of terminals is touched by the can, the circuit is completed. A battery then fires an electric detonator and the explosive charge. If the trip wire is pulled, the can rides up within the frame and closes the top pair of contacts. If the wire is cut or broken, gravity causes the can to drop and close the bottom pair of contacts. Two nails, acting as safety pins, are used for setting up the device, one below and one above the can.

Comments: The test history of this item is not known. The device appears to be workable.

Reference: (C) FSTC 381-5012, Typical Foreign Unconventional Warfare Weapons (U), Army Materiel Command, Sep 1964, pages 22 and 23.

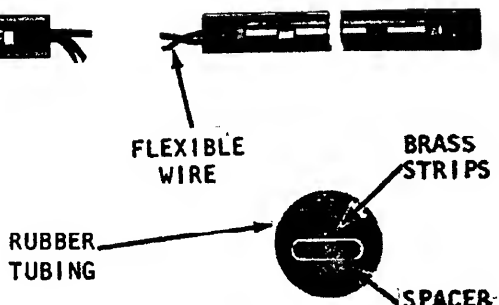

Description: This switch, No. 11 MK I, is employed to destroy wheeled or tracked vehicles. It is composed of two arms each 2 feet, 9 inches long that are laid across a road surface in the path of enemy approach. The two arms are connected by a double lead flexible wire. Another double lead flexible wire is provided with lugs for attaching to a battery supplied with the switch. The arms contain two brass strips held apart by insulating spacers every six inches. The strips are inclosed in red rubber tubing, closed at the end with waterproof rubber plugs. Passage of a vehicle over either arm, forces the brass strips into contact, completing the circuit.

Comments: The test history of this item is not known. The device is presumed to be effective.

Reference: (C) TM 9-1985-1, British Explosive Ordnance (U), page 433.

BRITISH BALL SWITCH

26-21

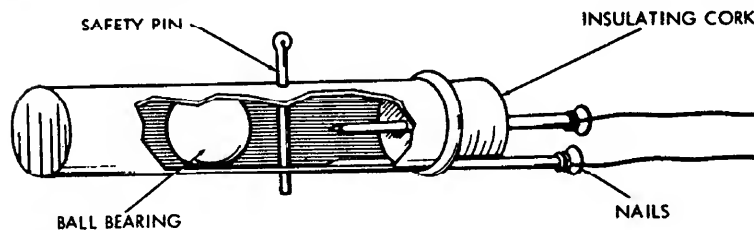

TAGO 6834B

Description: This device consists of a metal tube, a cork, a ball bearing, and 2 nails arranged as shown. The safety pin is withdrawn when the switch is installed. As long as the left end of the tube is lower than right end, the ball bearing does not connect the nail that protrudes from the center of the cork. However, when the tube is rotated sufficiently in the opposite direction, gravity rolls the bearing into contact with the nail and completes an electric circuit. Because of its particular adaptability to installation on door knobs, this device is commonly known as the *door knob device*.

Comments: The test history of this item is not known. The device appears to be workable.

Reference: (C) FSTC 381-5012, Typical Foreign Unconventional Warfare Weapons (U), Army Materiel Command, Sep 1964, pages 25 and 26.

Section 27. BOOBYTRAPS

FLN BOOK BOOBYTRAP

27-1

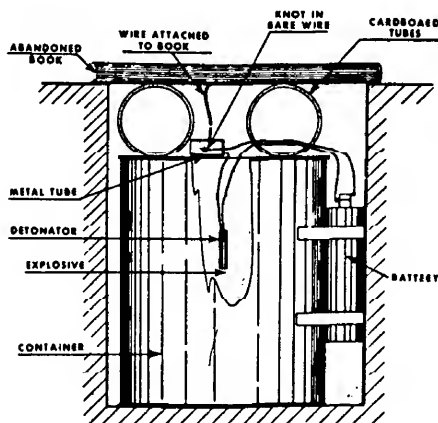

Description: This device is a boobytrap that is initiated by the sliding or lifting of an apparently abandoned book. The book may be placed on the ground, on top of a specially constructed bookcase, or on top of other books placed upright in an ordinary bookcase. Movement of the book activates an electrical explosive system. The electric circuit consists of insulated wire leads from a battery, through a detonator, a metal tube, and return to the battery. An open circuit condition exists when the knotted bare wire end of the insulated battery lead rests inside the metal tube but does not touch it. When the book is disturbed,

the metal tube is moved, causing the bared wire knot to contact the tube, thus completing the electric circuit.

Comments: The test history of this item is not known. The device appears to be workable.

Reference: (C) FSTC 381-5012, Typical Foreign Unconventional Warfare Weapons (U), Army Materiel Command, Sep 1964, pages 37 and 39.

JAPANESE BOOBYTRAPPED TELEPHONE

27-1

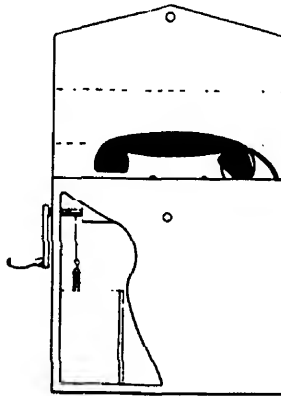

Description: This boobytrap uses the ringing handle of a telephone to set off a charge of explosive. A pull-operated fuze, inserted in the explosive, is connected to the handle by a wire. When the handle is turned, a pull is exerted on the fuze, causing it to function and detonate the explosive charge.

Comments: The test history of this item is not known. The device appears to be workable.

Reference: (C) FSTC 381-5012, Typical Foreign Unconventional Warfare Weapons (U), Army Materiel Command, Sep 1964, pages 36 and 38.

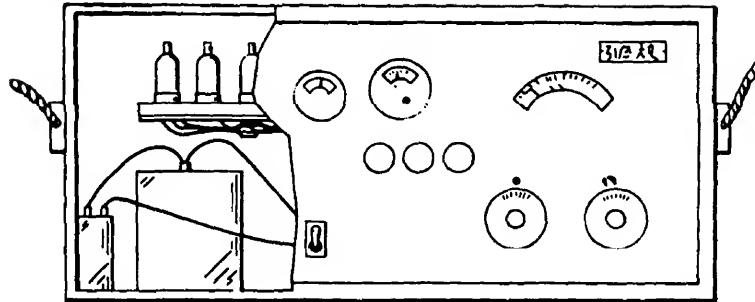

Description: This device is a Japanese radio. Hidden within the cabinet are a battery and an explosive charge that contains an electric detonator. The electric circuit is completed through the on-off switch of the radio. The device explodes when the switch is turned on.

Comments: The test history of this item is not known. The device appears to be workable.

Reference: (C) FSTC 381-5012, Typical Foreign Unconventional Warfare Weapons (U), Army Materiel Command, Sep 1964, pages 36 and 37.

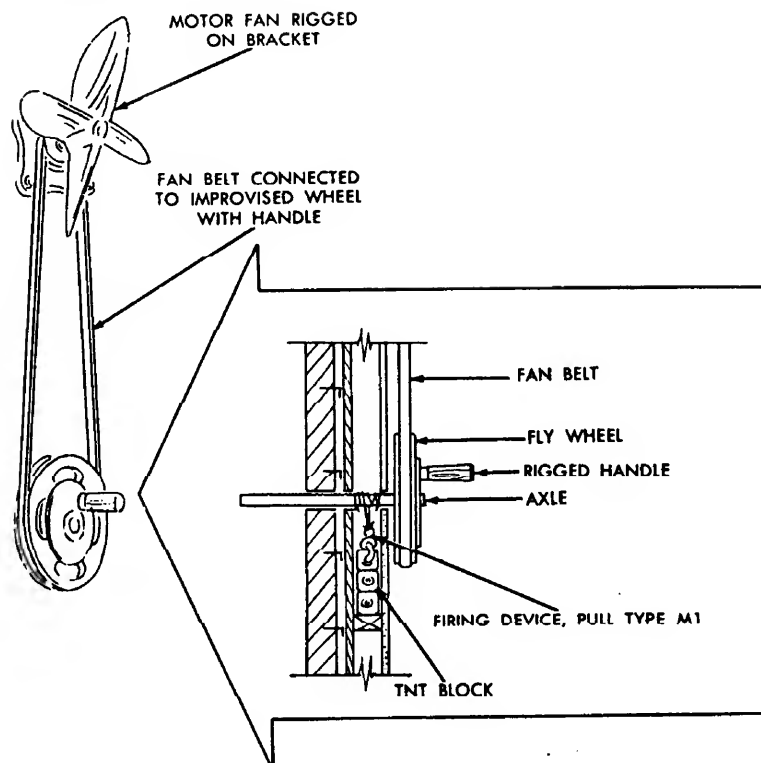

Description: A "Whatzis" is the name given to any kind of unusual rig, having at least one moving part, that invites the curious to handle it. Such a rig can be constructed from machine, automotive, or plumbing parts found in a junk pile. The "Whatzis" shown above consists of a motor fan driven by a belt-connected crank. The concealed pull-type firing device fastened to the moving part will set off an explosive charge when the crank is turned.

Comments: The test history of this item is not known. The device appears to be workable.

Reference: FM 5-31, Boobytraps, page 120.

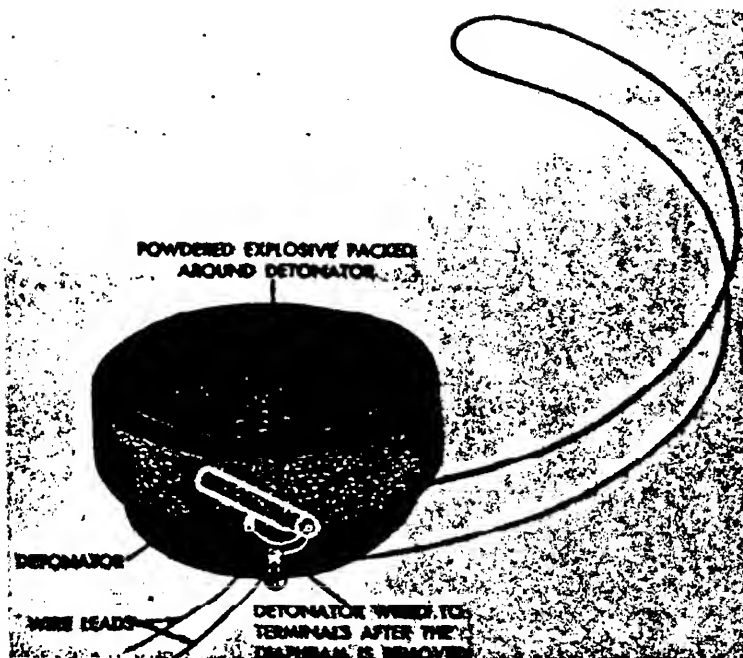

Description: This device consists of an electric detonator encased in an explosive that is then placed in the telephone ear piece. The detonator leads are connected to the terminals on the back of the earpiece. When these terminals are attached to a live communication line and a switch is closed to complete the circuit, the current will set off the electric detonator. Even a small charge of explosives detonated near the ear will cause serious injury.

Comments: The test history of this item is not known. The device appears to be workable.

Reference: FM 5-31, Boobytraps, page 138.

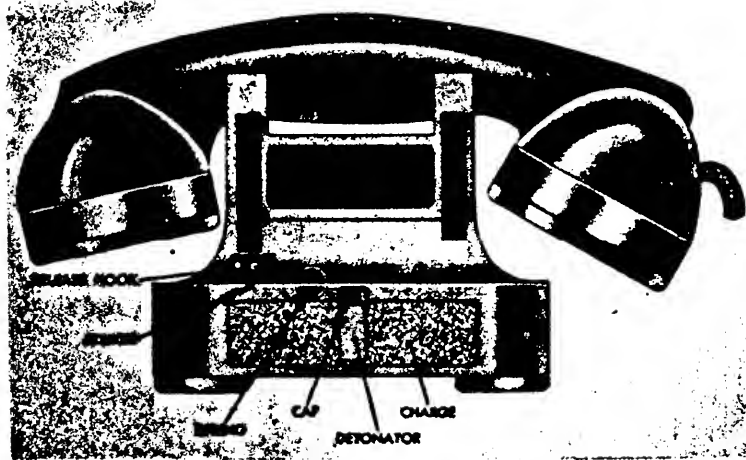

Description: This illustration shows a method of boobytrapping a common desk-type telephone. After removing the electric components of the instrument, the case is filled with an explosive charge that is set off by a detonator embedded in it. When the hand set is lifted, the raised cradle switch permits the release hook to turn and release a spring-driven striker. The striker is then driven against the detonator. Detection of this type of boobytrap is most difficult. This is an illustration of a complicated design requiring special equipment and ample time for preparation.

Comments: The test history of this item is not known. The device appears to be workable.

Reference: FM 5-31, Boobytraps, page 116.

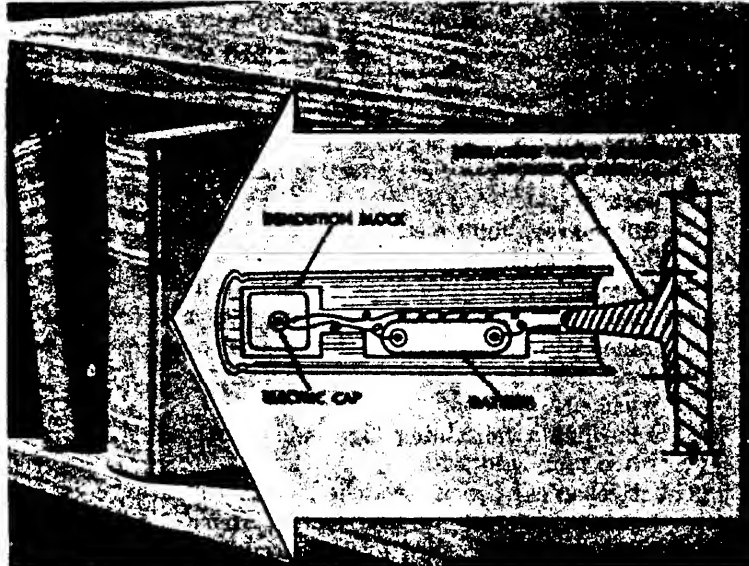

Description: The device shown in cross-section consists of an imitation book boobytrap that detonates upon being withdrawn from the shelf. The center portion of the book is hollowed out, leaving the outside appearance undisturbed. While standing on the shelf, the electric contacts are kept apart by the insulating wedge. When the book is grasped, finger pressure will close the contacts to complete an electric circuit through a battery and electric cap. The cap then sets off the concealed demolition block.

Comments: The test history of this item is not known. The device appears to be workable.

Reference: FM 5-31, Boobytraps, page 136.

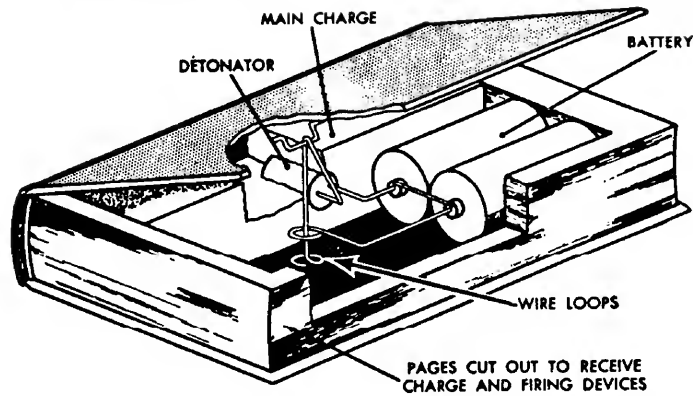

Description: This device consists of a hollow book containing explosive charge, flashlight battery, electric detonator, wire-loop contacts, and connecting wires. When the cover of the book is raised, the wire loops touch each other to complete the electric circuit and fire the charge.

Comments: The test history of this item is not known. The device appears to be workable. It is typical of the simplicity of construction used in Soviet dirty trick devices. Neutralizing a boobytrap of this kind should never be attempted.

Reference: FM 5-31, Boobytraps, page 135.



Description: The bottle shown contains a liquid explosive that detonates upon extraction of the cork. The cork is designed with a friction element that pulls through and initiates a sensitive explosive. When suitable corks and liquid explosives are provided, empty bottles may be rigged to trap an inquisitive enemy.

Comments: The test history of this item is not known. The device appears to be workable.

Reference: FM 5-31, Boobytraps, pages 136 and 137.

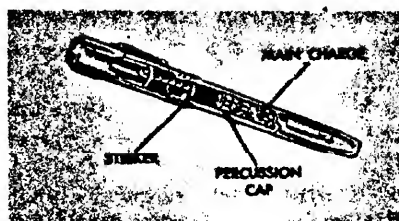

Description: This device is small for a boobytrap because the available space for an explosive charge is quite limited. However, the pen is made into a boobytrap that uses a spring-actuated striker to fire a

percussion cap that detonates an explosive charge. The striker is set in motion when an attempt is made to unscrew the cover.

Comments: The test history of this item is not known. The device appears to be workable. It would be difficult to improvise this manufactured item because of the small available space.

Reference: FM 5-31, Boobytraps, pages 136 and 137.

BRITISH FLASHLIGHT BOOBYTRAP

27-11

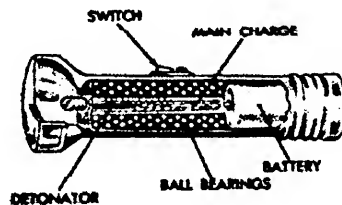

Description: The device shown uses the original dry cell battery, switch, and circuit of a flashlight. A standard electric detonator is coupled into the circuit and an explosive surrounds the detonator. Small ball bearings or metal scraps are placed around the explosive. When the switch is closed, detonation occurs, propelling the bearings at high velocity.

Comments: The test history of this item is not known. The device appears to be workable.

Reference: FM 5-31, Boobytraps, pages 136 and 137.

JAPANESE PIPE BOOBYTRAP

27-12

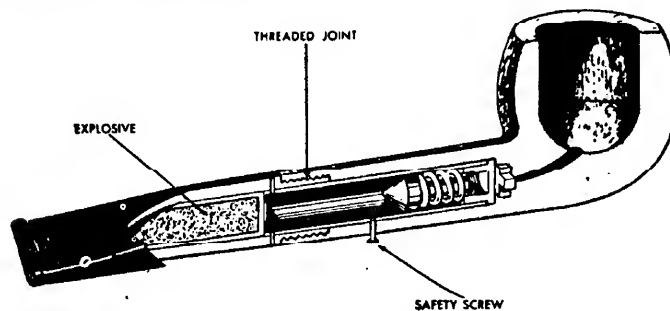

Description: This pipe contains a spring-loaded striker that is set in motion to detonate an explosive on attempts to unscrew the pipe stem. A safety screw, when in place, prevents removal of the pipe stem.

Comments: The test history of this item is not known. The device appears to be workable. It would be difficult to improvise this manufactured item because of the small available space.

Reference: FM 5-31, Boobytraps, page 137.

GERMAN CANTEEN BOOBYTRAP

27-13

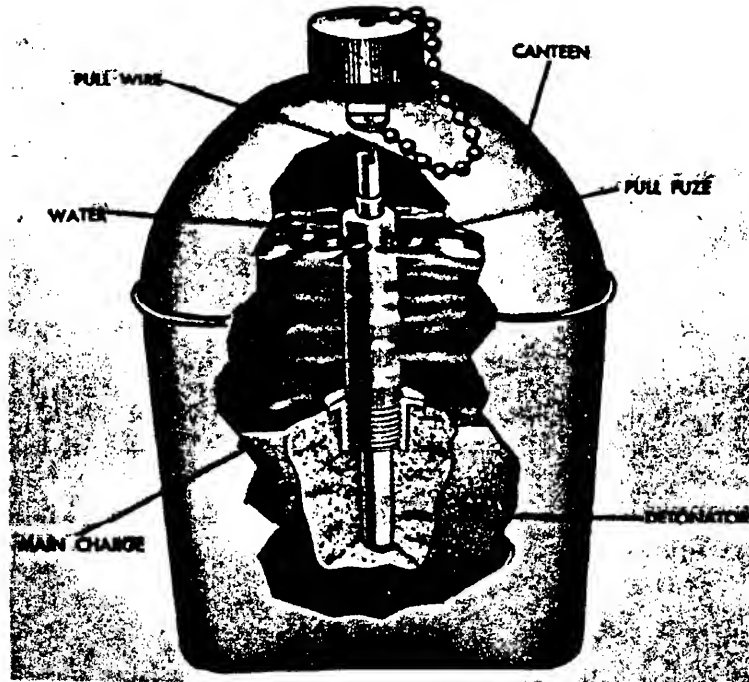

Description: The device shown consists of a standard German or United States canteen containing an explosive charge. A pull fuze is connected to the canteen cap by a wire. When the cap is removed, the fuze ignites a detonator which in turn sets off the main charge. Partially filled with water and placed in its canvas case, the canteen is a deceptive boobytrap. Its effective radius is from 3 to 4 yards.

Comments: The test history of this item is not known. The device appears to be workable.

Reference: FM 5-31, Boobytraps, pages 138 and 139.

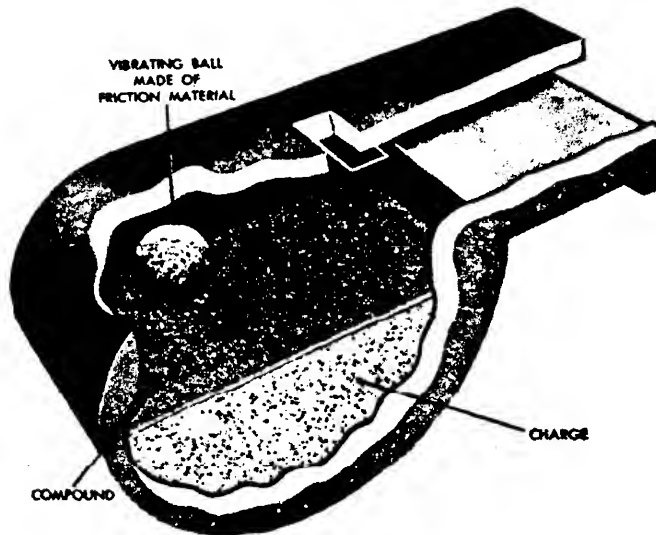

Description: This device consists of a whistle containing a charge coated with a compound that is easily ignited by heat from friction. The ball in the whistle is coated with rough material. When the whistle is blown, the ball vibrates and the friction developed between the ball and the explosive compound fires the charge.

Comments: The test history of this item is not known. The device appears to be workable.

Reference: FM 5-31, Boobytraps, pages 139 and 140.

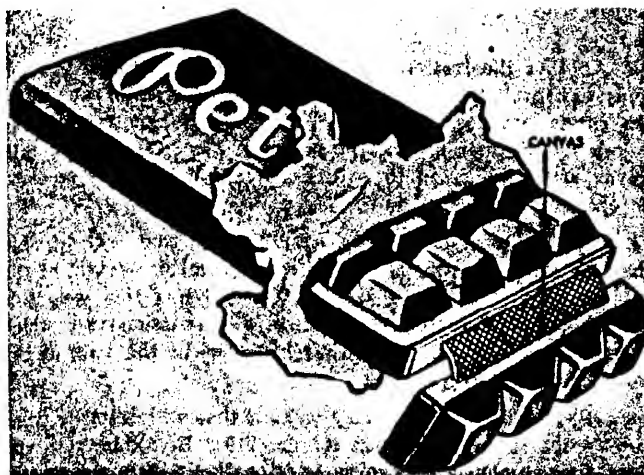

Description: The device shown consists of an imitation candy bar coated with real chocolate. When a piece is broken from either end of the bar, pull is exerted on a thin canvas strip connected to a fuze and explosive charge concealed in the center of the bar. After a delay of 7 seconds, the charge explodes.

Comments: The test history of this item is not known. The device appears to be workable.

Reference: FM 5-31, Boobytraps, pages 139 and 140.

UMBRELLA BOOBYTRAP

27-16

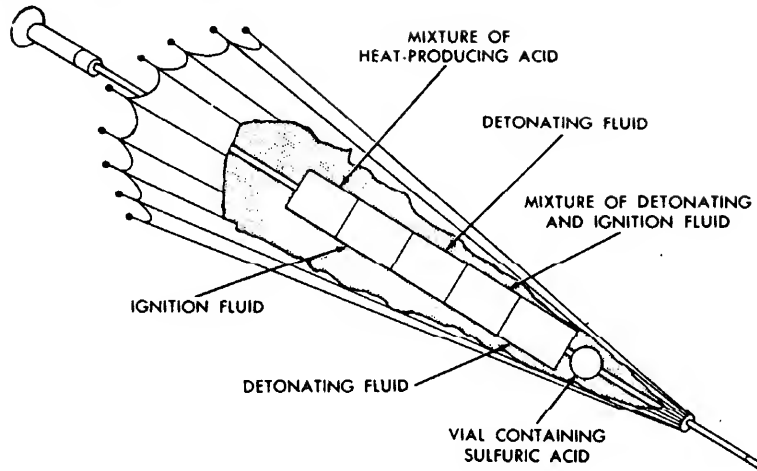

Description: The device shown consists of an imitation umbrella that will detonate when an attempt is made to open it. Breaking a vial containing sulphuric acid initiates a detonator that sets off a charge of high explosive.

Comments: The test history of this item is not known. The device appears to be workable.

Reference: FM 5-31, Boobytraps, pages 139 and 141.

JAPANESE EXPLOSIVE FOOD CAN

27-17

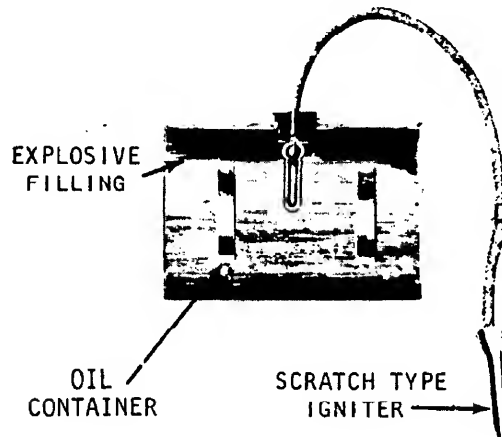

Description: Explosive "food cans" have been used as sabotage devices or boobytraps depending on the type of initiating system used. The "tin of strawberries" is typical and consists of a standard #2 can filled with high explosive. The tin bears a cleverly counterfeited *Libby's Strawberries* label, that covers and conceals a threaded igniter pocket in the side of the can. Two rectangular metal containers of heavy mineral oil are placed in the main filling on either side of the igniter pocket. Three different types of igniters are used with scratch type initiators.

Comments: The test history of this item is not known. The device is presumed to be workable.

Reference: TM 9-1985-4, Japanese Explosive Ordnance, page 260.

SOVIET PRESSURE-RELEASE BOOBYTRAP

27-18

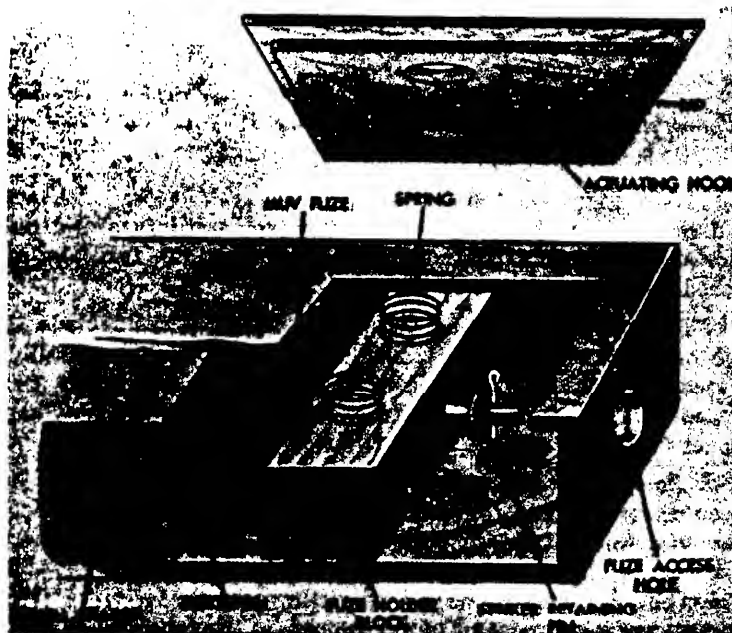

Description: The device shown consists of a wooden container that conceals a firing mechanism and explosive. It is placed under any object. Upon removal of the object, the two compressed springs push the lid

up and the hook pulls the striker-retaining pin out of the fuze, thus firing the device.

Comments: The test history of this item is not known. The device is presumed to be workable.

Reference: FM 5-31, Boobytraps, page 151.

GERMAN PRESSURE-RELEASE BOOBYTRAP

27-19

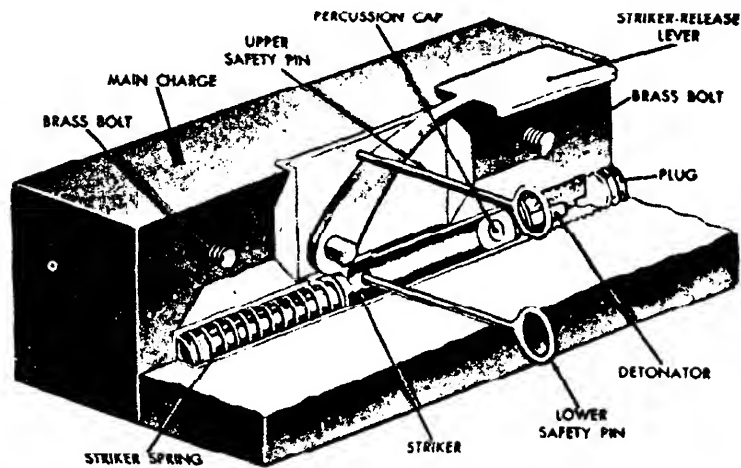

Description: The device shown consists of a wooden block that conceals a firing mechanism and explosive. In operation, the boobytrap is hidden below an object, one that the enemy is expected to pick up, and the two safety pins are withdrawn. When the object is removed, the striker release lever lifts, thus permitting the striker spring to force the striker into the detonator that in turn sets off the main explosive charge.

Comments: The test history of this item is not known. The device appears to be workable.

Reference: FM 5-31, Boobytraps, pages 146 and 147.

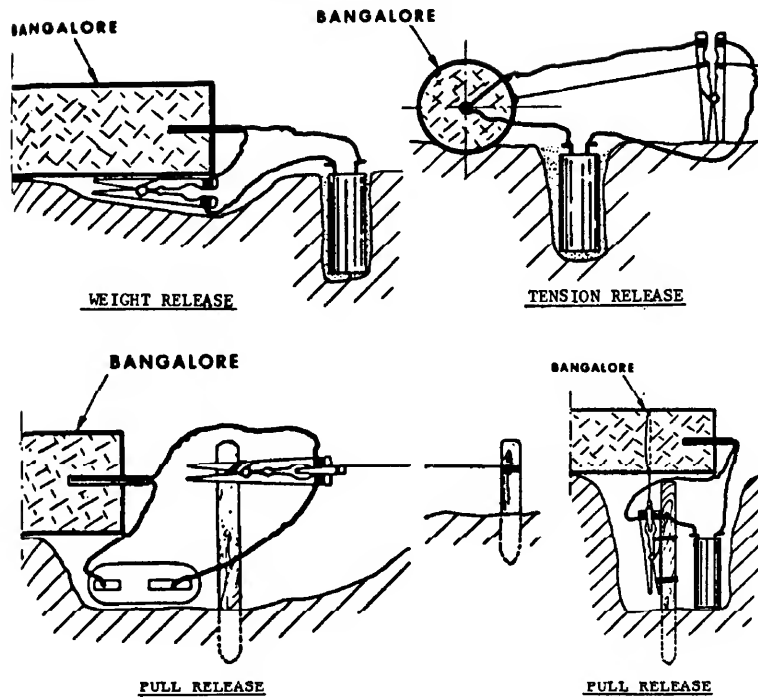

Description: The illustrations show four different ways in which a clothespin device is used to boobytrap a bangalore torpedo. One weight release, one tension release and two pull operated versions are included. All of the set-ups act as an antidisturbance device; that is, when the bangalore torpedo is disturbed, the jaws of the clothespin will be caused to touch thus completing an electric circuit, that will detonate the explosive.

Comments: The test history of these items is not known. They are presumed to be workable. Although these devices are shown with a bangalore torpedo, they can be employed in a similar way with any other explosive charge.

Reference: (C) FSTC 381-5012, Typical Foreign Unconventional Warfare Weapons (U), Army Materiel Command, Sep 1964, pages 37 and 40.

VIET CONG DOUBLE-SPIKE CALTROP

27-21



Description: This device is one type of caltrop used by the Viet Cong. It consists of a board with nails driven through it. The points are barbed to make removal from the victim more difficult. The Viet Cong have used these devices with as many as seven points from 2 to 12 inches long. Occasionally, fecal matter or other filth is smeared on the points to cause infection.

Comments: The test history of this item is not known. The device appears to be effective.

Reference: (C) FSTC 381-5012, Typical Foreign Unconventional Warfare Weapons (U), Army Materiel Command, Sep 1964, page 35.

VIET CONG DOUBLE-BARBED SPIKE

27-22



Description: The item shown is an improved caltrop spike. The improvement consists of a second barb pointed in a different direction to that of the first. This arrangement makes removal more difficult. In use, a number of these spikes would be driven through a board so as to stand upright.

Comments: The test history of this item is not known. The device appears to be workable.

Reference: (C) FSTC 381-5012, Typical Foreign Unconventional Warfare Weapons (U), Army Materiel Command, Sep 1964, page 36.

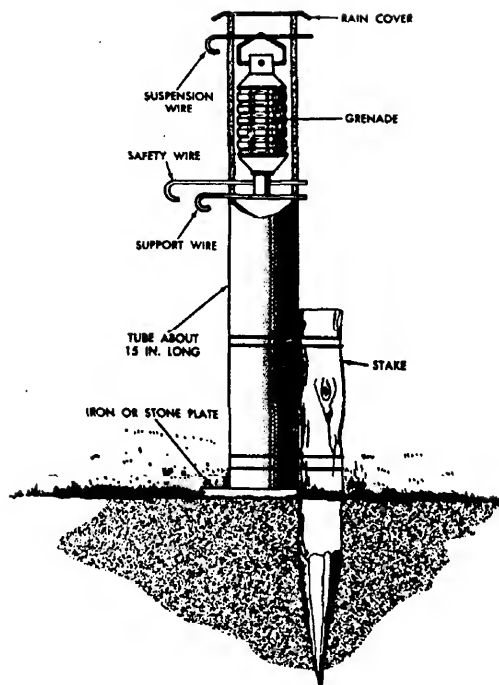

Description: The device shown is a hand grenade boobytrap. It consists of a tube of steel, iron, bamboo, or similar material, about 15 inches long, and of sufficient diameter that a grenade can slide loosely down its hollow center. Three holes drilled through the tube accommodate safety, suspension, and supporting wires. After the support wire and safety wire are removed, the suspension wire holds the grenade in the top of the pipe that in turn is attached to a stake or tree. When the suspension wire is removed by pull on a trip-wire, the grenade drops to the bottom, igniting its fuze. Detonation of the grenade occurs from 4 to 7 seconds later.

Comments: The test history of this item is not known. The device appears to be workable.

Reference: FM 5-31, Boobytraps, pages 165 and 166.

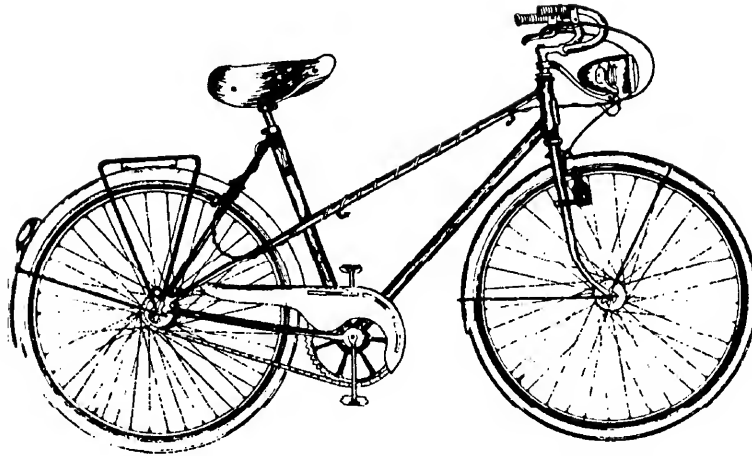

Description: The bicycle shown has been rigged to serve as a booby-trap. The main charge and an electric detonator are held in the upright tube of the frame under the saddle. An electric wire is wound outside the frame to lead to a watch and two 4.5-volt batteries that are placed inside the bicycle headlight. During movement, the ignition device is not linked to the explosive. Upon arrival at the desired site, these two components are connected, and the watch is preset to detonate the charge some time later.

Comments: The test history of this item is not known. The device appears to be effective.

Reference: Report EODS-65-3, Viet Cong's Explosive Ordnance Used in South Vietnam, U. S. Naval School, Explosive Ordnance Disposal, Jul 1965, page 2.

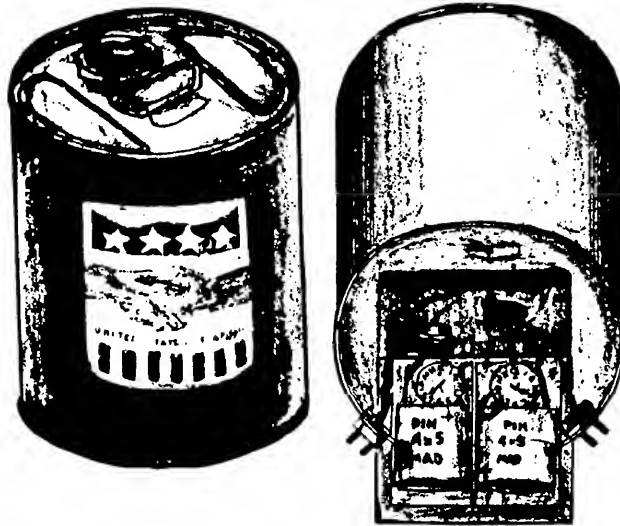

Description: This is a homemade boobytrap that functions by electricity and is exploded by a time delay firing device. The fabrication is as follows: The explosive is placed in a US 5-gallon can. A rectangular hole is cut in the bottom with a hinged cover under which a firing device is placed. The ignition device is composed of two 4.5 volt batteries and two watches. Duplication makes the device more reliable. The can contains 45 pounds of explosives. Two holes have been bored on the center plate and two wires from the explosive go through these holes and connect to two outer plugs. The watches are then adjusted to explode the mine at a prescribed time. At the prescribed time, the hour hand touches a copper screw inserted into the watch crystal. Electricity from the battery will flash to the ignition device and the explosive will detonate.

Comments: The test history of this item is not known. The device appears to be effective.

Reference: Report EODS-65-3, Viet Cong's Explosive Ordnance Used in South Vietnam, U. S. Naval School, Explosive Ordnance Disposal, Jul 1965, pages 66 and 67.

Section 23. MINES

ANTIPERSONNEL MINE, M14

28-1

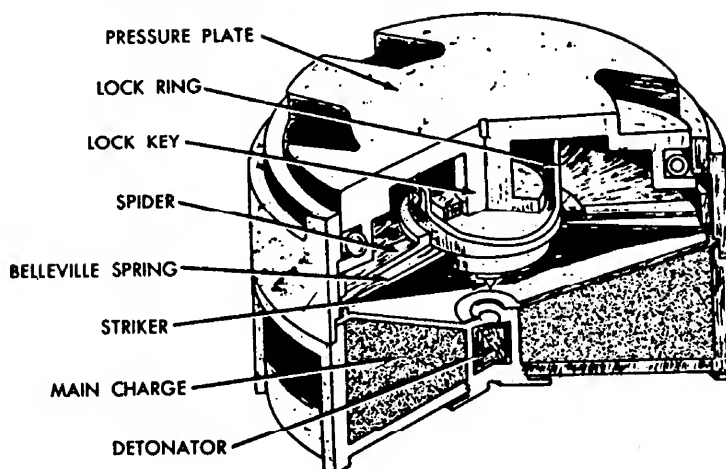

Description: The M14 mine, shown, is the smallest standard U. S. anti-personnel mine. Weighing only $4\frac{1}{2}$ ounces, the M14 contains about 1.1 ounces of tetryl, sufficient in detonation to be effective against personnel within 2 or 3 yards. Its lethal effect is derived primarily from concussion. The two-part plastic case of this mine is cylindrical, approximately $2\frac{1}{4}$ inches in diameter and $1\frac{1}{2}$ inches high. The upper part of the case contains an integral fuze. A belleville spring to which the firing pin is attached, fits into a recess into the lower part of the upper case. The lower part contains the detonator well and the main tetryl charge. In the unarmed position, the mine is safe. To arm the mine, the safety clip (not shown) is removed. The pressure plate can then be turned so that lock ring and key are disengaged. A load of 20 to 35 pounds on the pressure plate causes the fuze to function, releasing the belleville spring that drives the firing pin into the detonator, thus exploding the main charge.

Comments: This item was tested. It is effective.

References: FM 5-31, Boobytraps, pages 133 and 134.
TM 9-1900, Ammunition, General, pages 238 through 243.

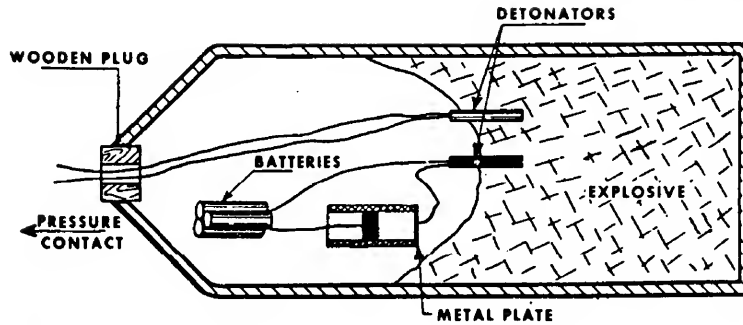

Description: This mine is made from an artillery shell. An upper detonator is connected to a pressure-operated firing device that is not shown. The lower detonator is connected to batteries and a detonator box that are all within the shell body. The box consists of a nonmetallic tube having a metal end plate that is connected to the detonator. If the external firing device is detected, the person attempting to neutralize it will cut the external lead, thus disconnecting only the upper detonator. When the nose of the shell is lifted, a metal block in the detonator box slides against the metal plate completing an electric circuit and exploding the mine.

Comments: The test history of this device is not known. The device appears to be workable.

Reference: (C) FSTC 381-5012, Typical Foreign Unconventional Warfare Weapons (U), Army Materiel Command, Sep 1964, pages 19 and 20.

NORTH KOREAN OIL DRUM MINE

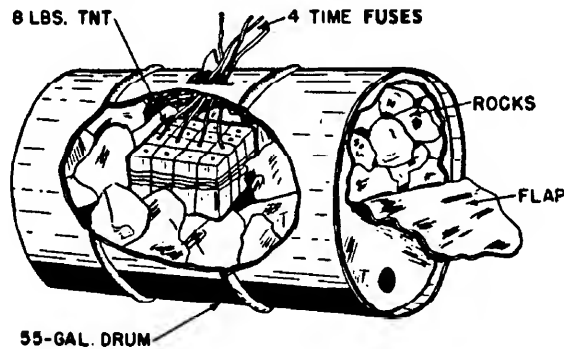

Description: This device consists of a 55 gallon drum filled with rocks, a charge of explosive and a number of time fuzes. The user places the device uphill from the anticipated route of his target. At the appropriate moment, he lights the fuzes, and then rolls the drum down the hill where it explodes amidst the enemy. Multiple fuzes, cut to the proper length, are used to increase the reliability of the device.

Comments: The test history of this device is not known. The device appears to be workable. A 100 pound wooden nail keg would also serve as a container.

Reference: (C) FSTC 381-5012, Typical Foreign Unconventional Warfare Weapons (U), Army Materiel Command, Sep 1964, page 15.

BRITISH GRENADE-IN-CAN MINE

28-4

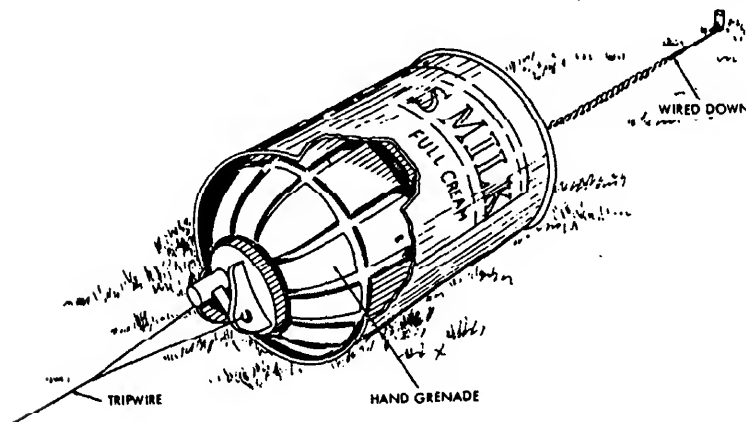

Description: One way in which a grenade can be used as a mine is shown. The device consists of a hand grenade, a tin can just large enough to fit over the grenade and its safety lever, and two lengths of string or wire. One length of string is fastened to the can, and then tied to a stake. The other wire is tied to the grenade, in such a way that it will not interfere with the functioning of the fuze, and then stretched across a road or pathway. The grenade is inserted into the tin can and the safety ring and pin are removed. A pull on the wire stretched across the path will drag the grenade from the can and permit it to function. The grenade could also be attached to a bag containing an explosive charge. The grenade, in this instance, would act as a fuze.

Comments: The test history of this device is not known. The device appears to be workable.

Reference: (C) FSTC 381-5012, Typical Foreign Unconventional Warfare Weapons (U), Army Materiel Command, Sep 1964, page 14.

JAPANESE IMPROVISED AIR STRIP MINE

28-5

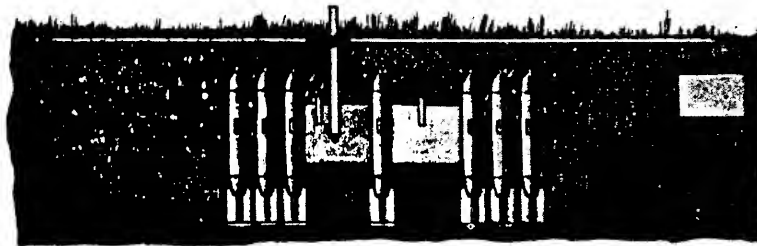

Description: This mine consists of thirty-one 100-kg bombs and picric acid blocks armed with electric detonators. The entire mine is laid in an air strip below a turf-covered piece of sheet iron. When the sheet is lifted or depressed, it touches electric contacts below a turf-covered piece of sheet iron that close a circuit and fire the charge. A clockwork mechanism is connected to the device to initiate the charge if the iron sheet is not disturbed.

Comments: The test history of this device is not known. The device appears to be workable.

Reference: TM 9-1985-4, Japanese Explosive Ordnance, page 220.

FLN FLAG MINE

28-6

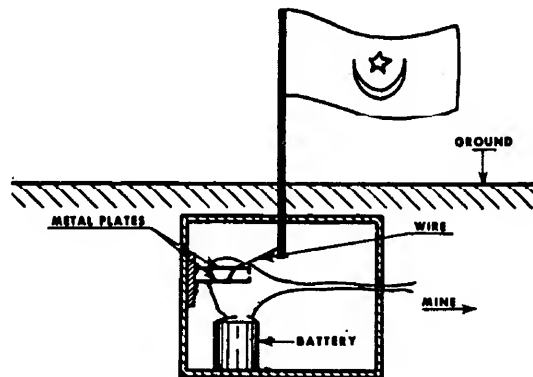

Description: The device shown is a box containing a battery and two contacts arranged so that an electric circuit can be closed by lifting the flagstaff. An explosive charge can be placed in any convenient place within a reasonable distance of the flagstaff. Another version of the flag mine is one which would be more appropriately called a flag booby-trap. It differs in that the explosive charge is placed inside the box.

Comments: The test history of this device is not known. The device appears to be workable.

Reference: (C) FSTC 381-5012, Typical Foreign Unconventional Warfare Weapons (U), Army Materiel Command, Sep 1964, page 41.

JAPANESE PRESSURE LAND MINE

2B-7

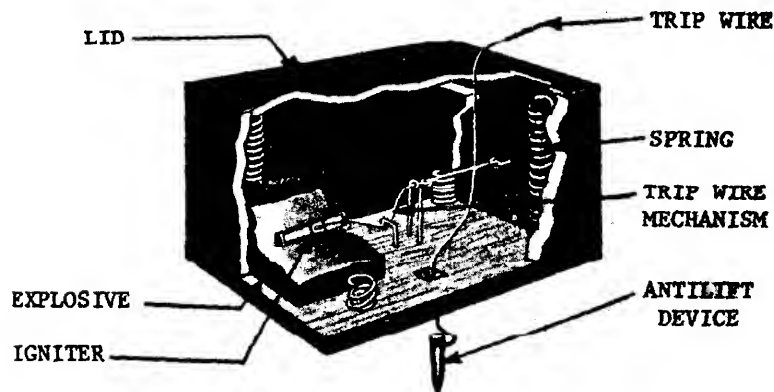

Description: This device was used as an antitank and antipersonnel mine. It consists of a wooden box containing high explosive, a friction-pull igniter and a trip-wire mechanism. The explosive is placed in a separate container and the igniter is inserted in the center block of three explosive blocks. The igniter consists of an igniter mix and a pellet composed of powdered glass mixed in red cement. The mine can be set off in three ways: pressure exerted on the lid, a pull on the trip wire, or by attempted removal of the mine, thereby actuating an anti-lift device.

Comments: The test history of this device is not known. The device appears to be workable.

Reference: TM 9-1985-4, Japanese Explosive Ordnance, page 217.

JAPANESE FRICTION-FUZED LAND MINE

28-8

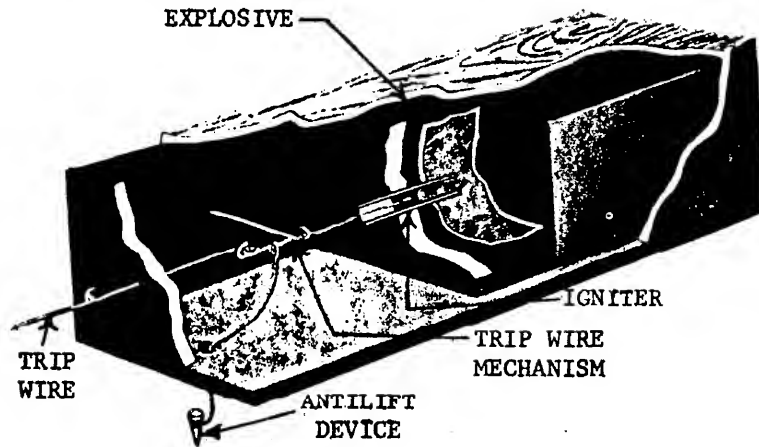

Description: This mine is usually buried 1 to 2 inches below the surface of the ground and is used as an antitank or antipersonnel mine. It consists of a wooden box, 3½ pounds of high explosive, a friction-pull igniter, and a trip wire mechanism. A partition holds five blocks of high explosive and also secures the igniter in position. The igniter is attached to the trip wire and to an antilift wire. The mine will function by a pull on the trip wire or by lifting the mine, thereby actuating the antilift device. In both instances, the pull igniter functions and detonates the explosive charge.

Comments: The test history of this device is not known. The device appears to be workable.

Reference: TM 9-1985-4, Japanese Explosive Ordnance, page 218.

JAPANESE IMPROVISED LAND MINE

28-9

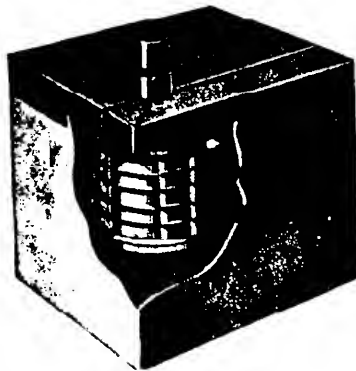

134

TAGO 6824B

Description: This mine, when fuzed with an armed grenade, is used as an antitank mine. With a pull or tension detonator, it can be used as an antipersonnel mine or boobytrap. The mine consists of a rectangular tin box, one Japanese type (91) hand grenade and twelve blocks of high explosive composed of 1/3 aluminum powder and 2/3 RDX. When used with a hand grenade for antitank use, the striker breaks a shear wire when struck with a sharp blow and penetrates a primer. After a 4 to 5 second delay, the grenade explodes and detonates the high explosive blocks. For antipersonnel use, a pull igniter with detonator is inserted into the charge and connected to a trip wire. When the trip wire is pulled, the igniter flash fires the detonator that in turn sets off the explosive.

Comments: The test history of this device is not known. The device appears to be workable.

Reference: TM 9-1985-4, Japanese Explosive Ordnance, page 219.

JAPANESE IMPROVED ANTITANK MINE

28-10

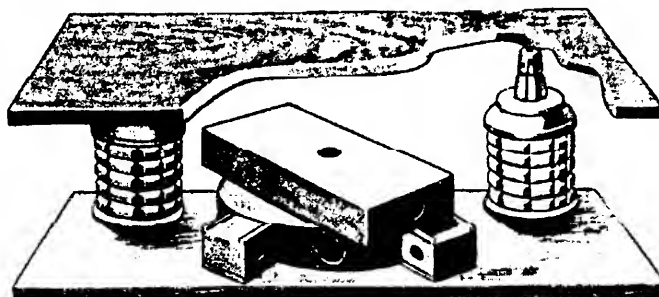

Description: This mine consists of two hand grenades, a two-pound prepared picric acid charge, and a Mod 99 armor piercing mine. The picric acid charge is laid on top of the mine and a hand grenade is placed on each side. A board is then laid over the two grenades so that pressure will actuate the grenades. Sympathetic detonation causes initiation of the main charge.

Comments: The test history of this device is not known. The device appears to be workable.

Reference: TM 9-1985-4, Japanese Explosive Ordnance, page 220.

BRITISH LIMPET, MK III

28-11

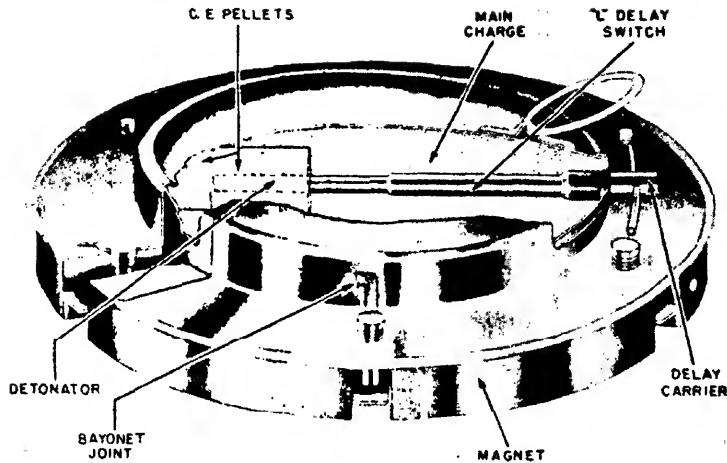

Description: The limpet is a small, self-contained, delay-action mine with a magnetic base. It can be quickly fitted to any iron or steel target, such as a tank or the hull of a ship. The device is designed to function either on land or under water. It carries a charge of 3½ pounds of high explosive filler which is sufficient to pierce 60mm plate. Exceptionally powerful magnets allow it to remain in place on the average marine vessel at speeds up to 16 knots. A standard Delay Switch No. 9, MK I with a Detonator No. 8 attached, serves as the delay initiator.

Comments: The test history of this item is not known. The device is presumed to be effective.

Reference: (C) TM 9-1985-1, British Explosive Ordnance (U), page 447.

FLN ANTIVEHICLE MINE

28-12

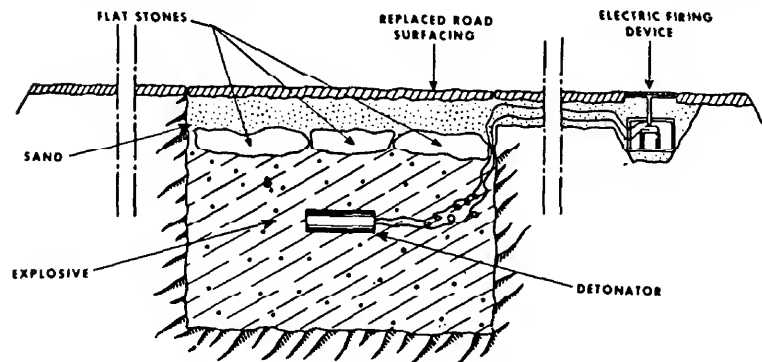

Description: The device shown is actually an uncased charge of explosive that fills a hole scooped from the center of the roadbed. The road surface is cut, lifted, and then carefully replaced over the device to minimize detection. The explosive is detonated when the wheel of a vehicle passes over an electric firing device placed in a wheel track.

Comments: The test history of this item is not known. The device is presumed to be effective.

Reference: (C) FSTC 381-5012, Typical Foreign Unconventional Warfare Weapons (U), Army Materiel Command, Sep 1964, pages 18 and 19.

FLN FOUGASSE

28-13

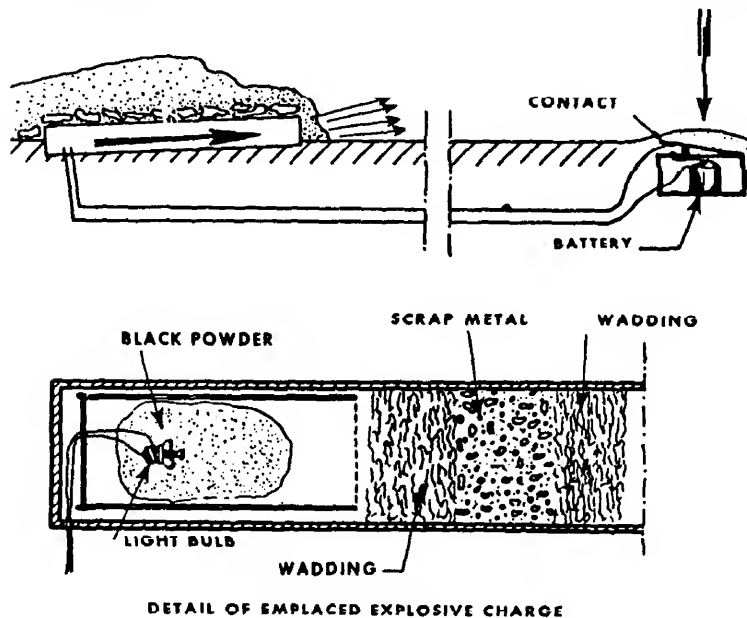

Description: The fougasse is an ancient device that resembles an overgrown shotgun. The top figure shows the entire installation including the electric contact that is placed across the road from the exploding part. The bottom figure shows in detail the structure of the charge portion of the fougasse. Note its resemblance to a shotgun. The black powder propellant is initiated by the filament of the light bulb in which the glass is broken away. The charge consists of scrap metal packed between packs of wadding. When the contact points are forced together, the fougasse is initiated. The weapon is usually aimed across a road, and when properly loaded, will damage unarmed vehicles and injure or kill troops.

Comments: The test history of this item is not known. The device is presumed to be effective. The FLN in Algeria used this device extensively.

Reference: (C) FSTC 381-5012, Typical Foreign Unconventional Warfare Weapons (U), Army Materiel Command, Sep 1964, pages 20 and 21.

GERMAN PISTOL GROUND SPIKE

28-14

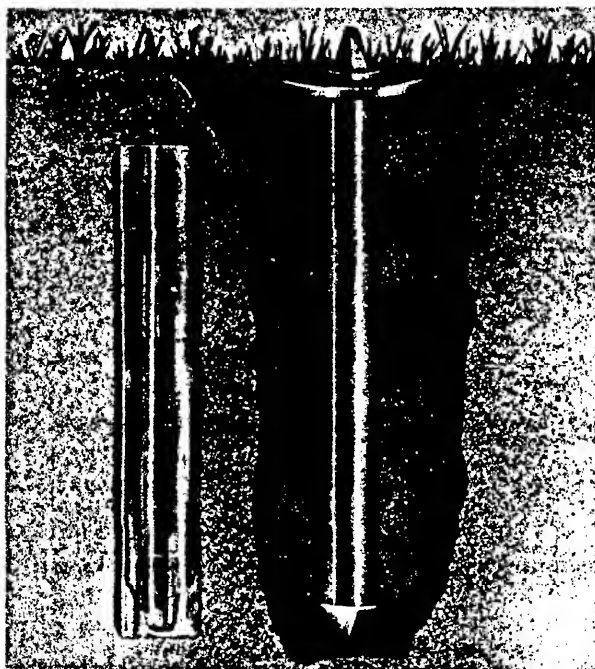

Description: The antipersonnel device shown above is buried in the ground to mine a path. Operating as a miniature mortar, the six-inch hollow spike of the device is driven into the ground flush with the surface. The projectile consists of a small arms cartridge that is dropped in the hollow spike, nose up. Stepping on the bullet exerts enough pressure (4 pounds minimum) to release a spring that drives a striker against the cartridge cap thus firing the round. Traveling upward, the bullet can penetrate foot, leg, or thigh. The device is easy to plant and hard to detect because little ground is disturbed.

Comments: The test history of this item is not known. The device is presumed to be effective. This device was used by German troops during World War II. It was nicknamed the "castrator" by American soldiers.

Reference: FM 5-31, Boobytraps, page 148.

SOVIET IMPROVED INFANTRY MINES

28-15

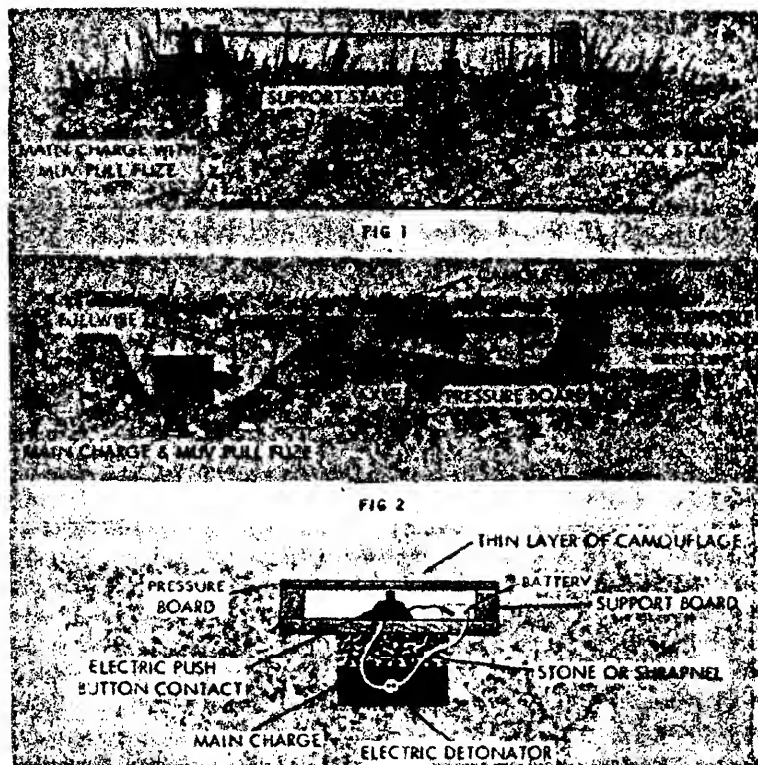

FIG 3

Description: A simple mine consists of a charge of explosive wired to a stake, a pull-actuated fuze, and a tripwire anchored to a second stake as shown in figure 1. Lethality of the device may be increased by piling rocks around the charge. The main disadvantage of using this device is difficulty in concealment. A more complex device, shown in figure 2, consists of a charge of explosive, a pull-actuated fuze, and a pivoted pressure board. A wire connects the retaining pin of the fuze striker with one end of the board. A flimsy support, such as a large

twig, prevents the other end of the board from moving downward while the device is being laid and camouflaged. Rocks may be piled around the explosive charge to provide a fragmentation effect. The mine shown in figure 3 is more difficult and dangerous to construct because the person who lays it must make certain that electric contact is open by checking with a circuit tester.

Comments: The test histories of these items are not known. The devices appear to be workable.

Reference: (C) FSTC 381-5012, Typical Foreign Unconventional Warfare Weapons (U), Army Materiel Command, Sep 1964, pages 15 through 17.

SOVIET SEESAW MINE

28-16



Description: This device consists of a baseboard, two axle posts, a charge of explosive with fuzes protruding from both ends, a tilt board, and two pull wires. The main charge and axle posts are mounted on the baseboard. The tilt board pivots on the axle posts. The pull wires are connected to the tilt board about halfway between the center and its extremities. When a force is applied to either end of the tilt board, a pull wire releases a striker pin, initiating a fuze, and firing the explosive charge.

Comments: The test history of this device is not known. This item appears to be workable.

Reference: (C) FSTC 381-5012, Typical Foreign Unconventional Warfare Weapons (U), Army Materiel Command, Sep 1964, pages 17 and 18.

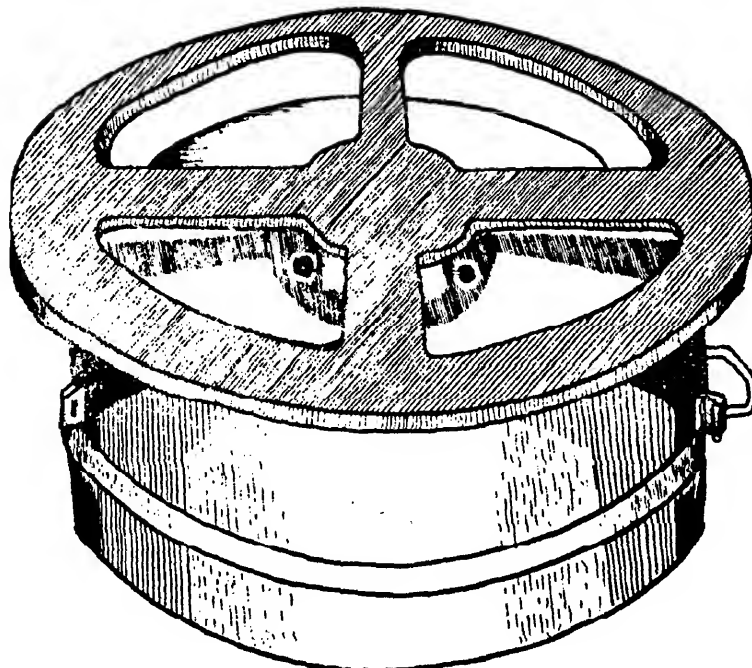

Description: This antipersonnel and antitank mine is made of cast iron and frequently painted black. It is 9 inches in diameter, 4 inches high, and weighs 12 pounds. In order to detonate the mine, a 30 pound pressure on the pressure ring is required. It can be detonated by a pull or friction firing device. The main charge is 5 pounds TNT or picric acid.

Comments: The test history of this item is not known. The device appears to be effective.

Reference: Report EODS-65-3, Viet Cong's Explosive Ordnance Used in South Vietnam, U. S. Naval School, Explosive Ordnance Disposal, Jul 1965, page 37.

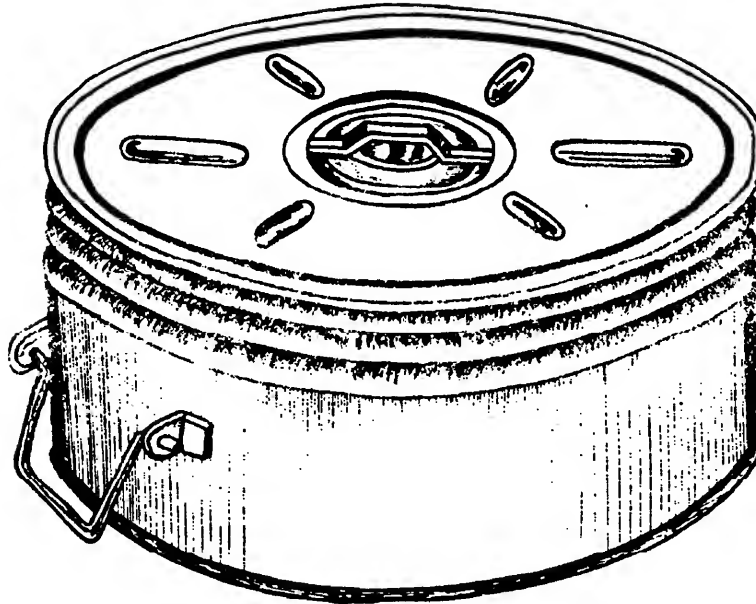

Description: This mine is made of sheet metal often painted white or dark olive drab. It is 10 inches in diameter, 5 inches high, and weighs 12 pounds. The pressure-type firing device, located under the pressure cap, requires 350 pounds of pressure to activate the mine. This mine can remain operative for many months when it is waterproof.

Comments: The test history of this item is not known. The device appears to be effective.

Reference: Report EODS-65-3, Viet Cong's Explosive Ordnance Used in South Vietnam, U. S. Naval School, Explosive Ordnance Disposal, Jul 1965, page 39.

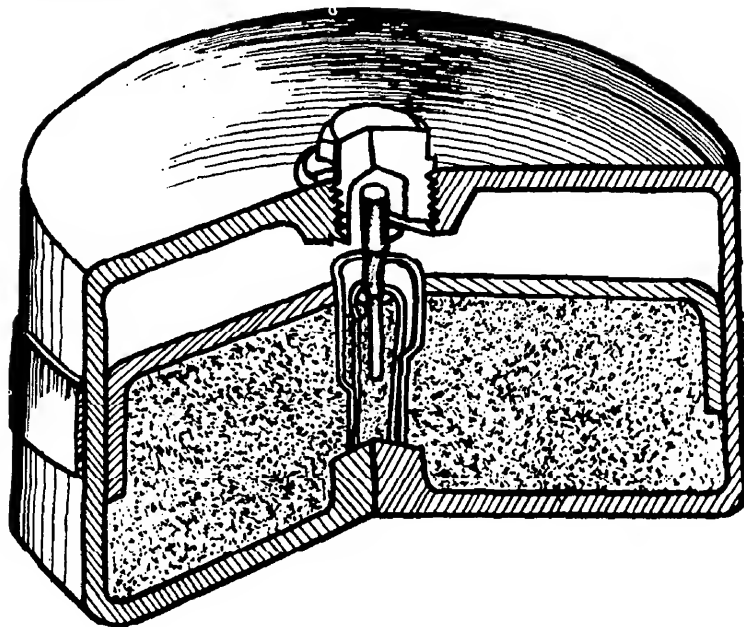

Description: The Russian TMB-2 mine is one of the standard, non-metallic, antitank mines used in the Soviet Army. It is laid separately or with metallic and wooden mines. The mine cannot be detected by a mine detector. The case is made of impregnated cardboard, 11 inches in diameter and 6 inches high. The mine weighs 15.4 pounds and contains 11 pounds of Amatol.

Comments: The test history of this item is not known. The device appears to be effective.

Reference: Report EODS-65-3, Viet Cong's Explosive Ordnance Used in South Vietnam, U. S. Naval School, Explosive Ordnance Disposal, Jul 1965, page 40.



Description: The Viet Cong locally constructed antitank mine with iron case consists of two parts, a cap or pressure plate and a body. Two holes are located in the top of the mine, one to accommodate the fuze and the other to load the explosive (TNT). The mine is 8 inches in diameter and 3 inches high. It weighs 11½ pounds.

Comments: The test history of this item is not known. The device appears to be effective.

Reference: Report EODS-65-3, Viet Cong's Explosive Ordnance Used in South Vietnam, U. S. Naval School, Explosive Ordnance Disposal, Jul 1965, page 41.



Description: This mine is modified British 100mm mortar shell (oval-shaped case) utilizing an electric firing device. The fuze well is cut off and a hole is drilled into the explosive to accommodate an electric blasting cap. The shell is made of cast iron, 4 inches in diameter and 15 inches long. It weighs 13 pounds and contains 3½ pounds of TNT.

Comments: The test history of this item is not known. The device appears to be effective.

Reference: Report EODS-65-3, Viet Cong's Explosive Ordnance Used in South Vietnam, U. S. Naval School, Explosive Ordnance Disposal, Jul 1965, page 42.

VIET CONG FRAGMENTATION MINE

28-22

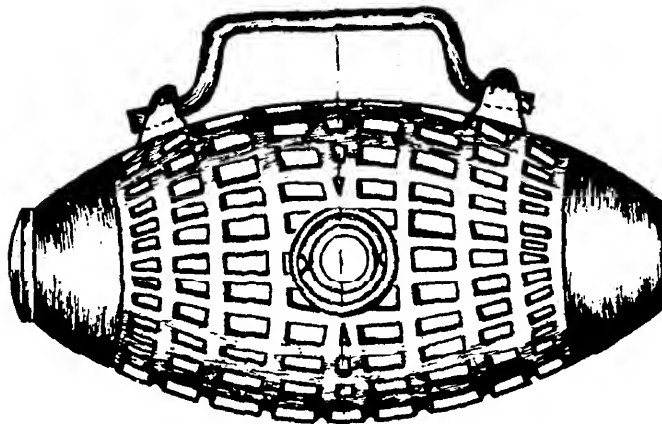

Description: This oval-shaped mine is crisscrossed by serrations except on the two ends. On the mine body and between the ends is a handle that is passed through two eye hooks attached to the mine body. There is a hole, 2 inches in diameter, with a cover at the end of the mine. When used, this cover is removed and replaced by an electric blasting cap. The mine is made of cast iron. It is 5 inches in diameter and 9 inches long. It weighs 12 pounds and contains Melinite explosive.

Comments: The test history of this item is not known. The device appears to be effective.

Reference: Report EODS-65-3, Viet Cong's Explosive Ordnance Used in South Vietnam, U. S. Naval School, Explosive Ordnance Disposal, Jul 1965, page 43.

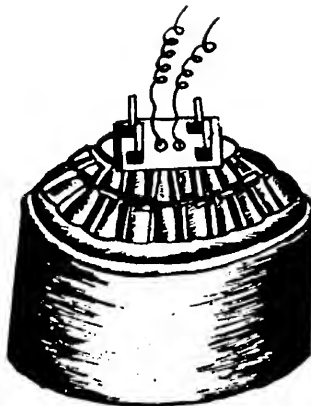

Description: This mine is constructed of cement with an electric firing device and serrations in the center of the case. The end of the mine has a piece of iron attached by four bolts to hold the electric blasting cap. The mine is 8 inches in diameter and 8 inches high. It weighs 13 pounds and contains TNT.

Comments: The test history of this item is not known. The device appears to be effective.

Reference: Report EODS-65-3, Viet Cong's Explosive Ordnance Used in South Vietnam, U. S. Naval School, Explosive Ordnance Disposal, Jul 1965, page 44.

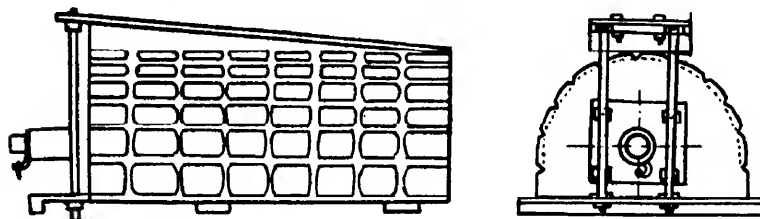

Description: This mine is constructed of cement with an electric firing device. Usually the mine is fastened to a long pole. A part of the case has a square piece of iron attached by four screws to hold the fuze in place. The mine is 5 inches in diameter and 9 inches long. It weighs 13 pounds and contains TNT.

Comments: The test history of this item is not known. The device appears to be effective.

Reference: Report EODS-65-3, Viet Cong's Explosive Ordnance Used in South Vietnam, U. S. Naval School, Explosive Ordnance Disposal, Jul 1965, page 45.

VIET CONG DIRECTIONAL FRAGMENTATION MINE, DH-10 28-25

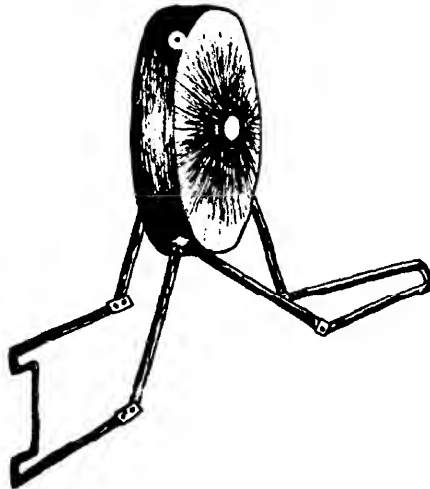

Description: The Viet Cong DH-10 mine is designed to counter massed infantry attacks and to be used against light-armored vehicles. It is also used against helicopters when discharging troops and to attack or sabotage airfields or airstrips. This mine can be fixed on bipods and placed on all types of terrain. The mine characteristics are similar to those of the US Claymore mine, M18A1. The mine is composed of two parts: Body and bipods. The saucer shaped body is constructed of sheet metal and painted olive drab. It is 12 inches in diameter and 2 inches wide. It weighs 20 pounds. The bipods are composed of four steel rods and two frames. The concave side of the mine is aimed at the objective so that when the mine explodes fragments will be short in an arc. (The body contains from 420 to 450 cylindrical steel fragments, each 12mm in diameter.) Effective range against personnel is 218 yards and against armor, 54 yards.

Comments: The test history of this item is not known. The device appears to be effective.

Reference: Report EODS-65-3, Viet Cong's Explosive Ordnance Used in South Vietnam, U. S. Naval School, Explosive Ordnance Disposal, Jul 1965, pages 46 and 47.

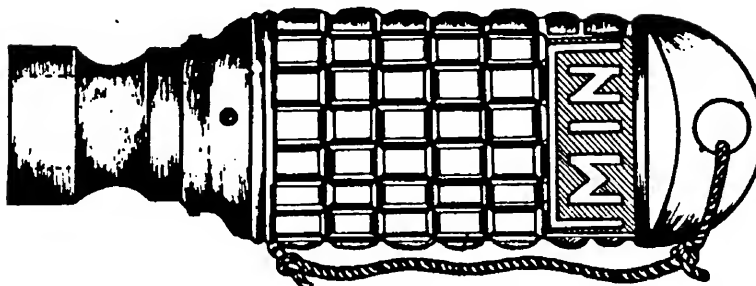

Description: This cylindrical, homemade mine is constructed of cast iron. The mine body is painted grey and has serrations for fragmentation effect. When the wire ring is pulled out, the friction-type igniter ignites the time fuze and detonates the blasting cap that in turn detonates the mine. The mine is 2 inches in diameter and 6½ inches long. It weighs 2 pounds and contains TNT.

Comments: The test history of this item is not known. The device appears to be effective.

Reference: Report EODS-65-3, Viet Cong's Explosive Ordnance Used in South Vietnam, U. S. Naval School, Explosive Ordnance Disposal, Jul 1965, page 49.

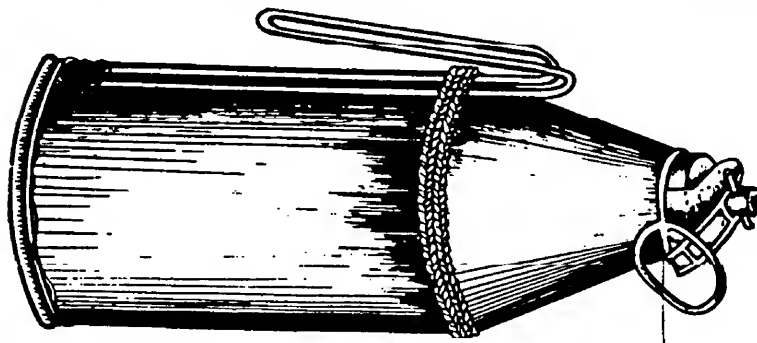

Description: This mine is constructed of sheet metal with a dark painted case. It is a modified grenade equipped with one iron (or tin) lug on its body. Its operation is similar to a homemade grenade. When the safety ring is pulled out, the spring is released and the firing pin strikes the primer and detonates the mine. The mine is 2 inches in diameter and 6 inches long. It weighs 2 pounds.

Comments: The test history of this item is not known. The device appears to be effective.

Reference: Report EODS-65-3, Viet Cong's Explosive Ordnance Used in South Vietnam, U. S. Naval School, Explosive Ordnance Disposal, Jul 1965, page 50.

VIET CONG CYLINDRICAL FRAGMENTATION MINE

28-28

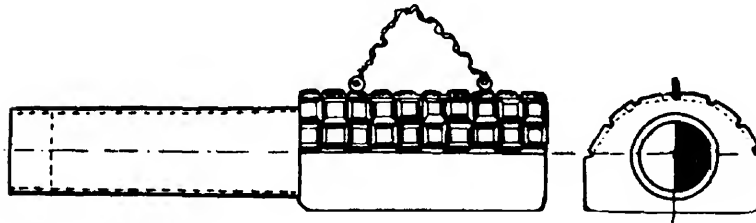

Description: This locally manufactured cylindrical fragmentation mine, with serrations, is constructed of cement; it is electrically fired. There are two iron swivels on the mine body to tie it to an object. On one side of the mine head is a round iron pipe and on the other side is a hole to accommodate the electric blasting cap. The mine is 7 inches wide and 22 inches long. It weighs 13 pounds and contains TNT.

Comments: The test history of this item is not known. The device appears to be effective.

Reference: Report EODS-65-3, Viet Cong's Explosive Ordnance Used in South Vietnam, U. S. Naval School, Explosive Ordnance Disposal, Jul 1965, page 51.

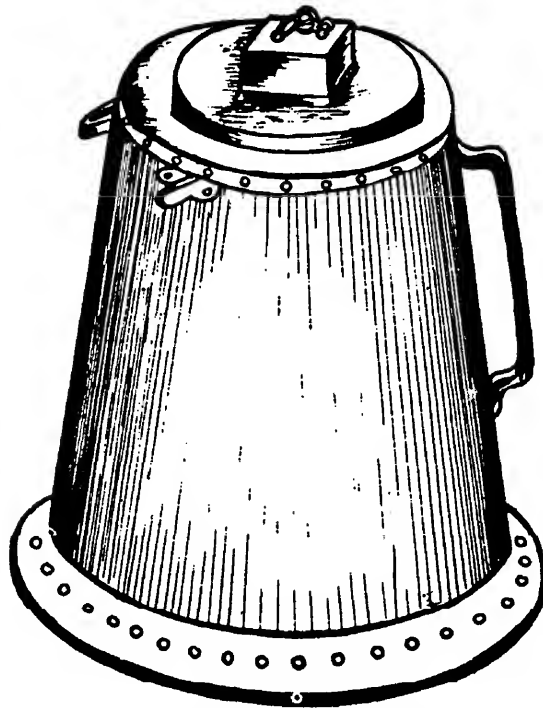

Description: This mine is cone shaped and made of sheet metal held together with rivets. It is equipped with two pressure-pull igniting devices that detonate the mine in 9 seconds. The mine is 9 inches in diameter and 8 inches high. It weighs 15 pounds. The igniting device is locally made. It consists of a Caltex oil can that contains two detonators, placed in parallel lines in the mine. The components of the mine are two pressure-pull strings, two igniting devices, two igniter charges, and two detonators.

Comments: The test history of this item is not known. The device appears to be effective.

Reference: Report EODS-65-3, Viet Cong's Explosive Ordnance Used in South Vietnam, U. S. Naval School, Explosive Ordnance Disposal, Jul 1965, page 53.

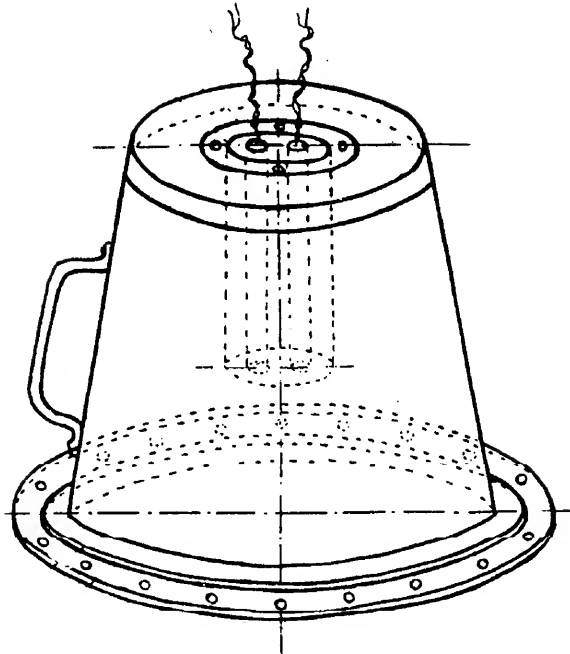

Description: The Viet Cong locally made short cone-shaped mine weighs 27 pounds and contains 15 pounds of TNT. The outer case is made of sheet iron. The upper part has two holes through which two electric blasting caps are introduced (to increase reliability). The mine has a bell-shaped base, 11 inches in diameter. A handle is attached to the side of the mine case by two rivets.

Comments: The test history of this item is not known. The device appears to be effective.

Reference: Report EODS-65-3, Viet Cong's Explosive Ordnance Used in South Vietnam, U. S. Naval School, Explosive Ordnance Disposal, Jul 1965, page 55.

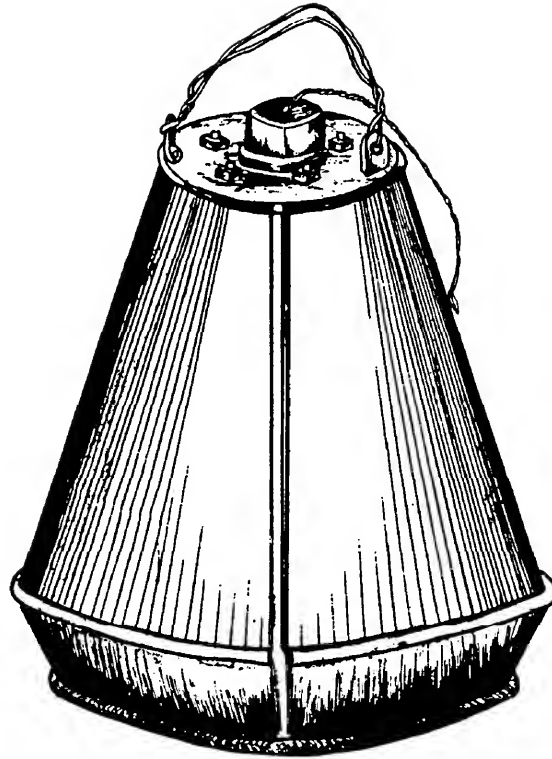

Description: The Viet Cong homemade water mine is constructed in the shape of a short cone and fabricated from sheet metal held together by rivets. The mine is usually painted black and marked with the number 4 at three different spots on its outer case. It is 11 inches in diameter and 12 inches high. It weighs 27 pounds and contains TNT. The mine is constructed in different sizes and is operated by electricity. It is employed to attack naval ships and boats.

Comments: The test history of this item is not known. The device appears to be effective.

Reference: Report EODS-65-3, Viet Cong's Explosive Ordnance Used in South Vietnam, U. S. Naval School, Explosive Ordnance Disposal, Jul 1965, page 57.

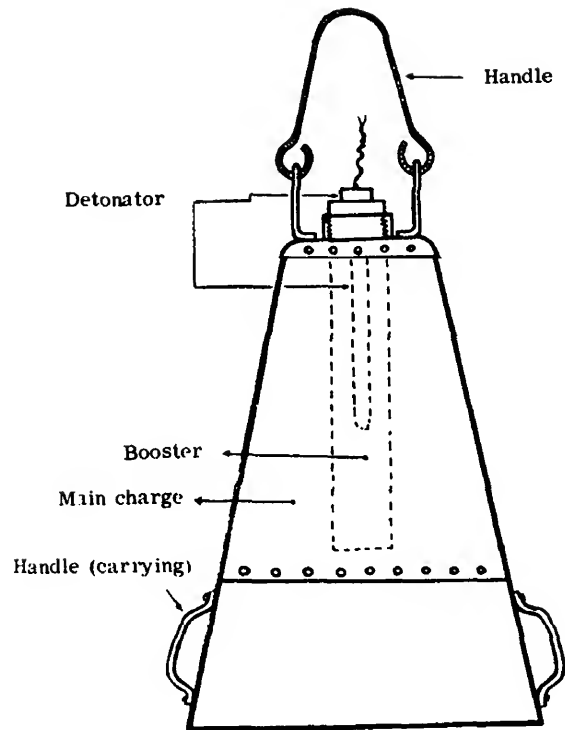

Description: The Viet Cong locally made water mine is used to attack ships. It is made of sheet iron rolled into a short conical shape and fastened with rivets. It is 17 inches in diameter and 22 inches high. It weighs 80 pounds. The mine is composed of two parts, upper and lower, that are separated by a piece of sheet metal. The upper part contains the firing device and main charge while the lower part is a hollow case designed to stabilize the water mine and keep it buoyant underwater. To stabilize the water mine underwater, the Viet Cong attach steel bars or wooden poles around the two handles attached to the outer side. The mine is asphalt coated but does not appear to be watertight.

Comments: The test history of this item is not known. The device appears to be effective.

Reference: Report EODS-65-3, Viet Cong's Explosive Ordnance Used in South Vietnam, U. S. Naval School, Explosive Ordnance Disposal, Jul 1965, page 59.

VIET CONG "TURTLE" MINE

28-33

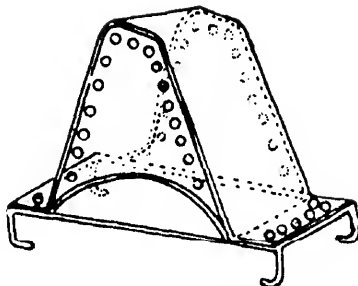

Description: This locally constructed mine is made of separate pieces of black sheet metal fastened together with rivets. There are four U-shaped supports placed across the bottom of the mine. The mine is 9 inches wide and 5½ inches high. It weighs 20 pounds and contains 7½ pounds of Melinite explosive.

Comments: The test history of this item is not known. The device appears to be effective.

Reference: Report EODS-65-3, Viet Cong's Explosive Ordnance Used in South Vietnam, U. S. Naval School, Explosive Ordnance Disposal, Jul 1965, page 62

VIET CONG MOUND-SHAPED MINE

28-34

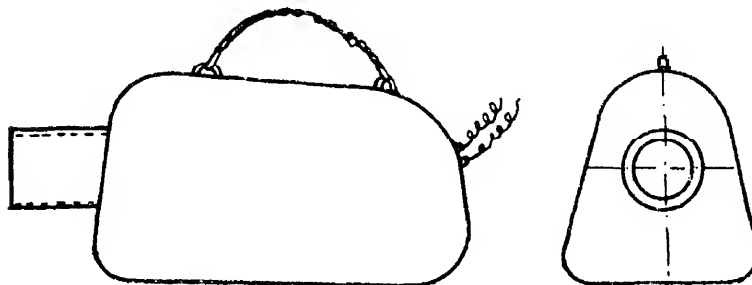

Description: This mine is constructed of cement and is electrically operated. There are two iron swivels on the mine body to tie it to an object. One side of the head has a round iron pipe, 2 inches in diameter, and the opposite side has a hole to accommodate an electric blasting cap. The mine is 12 inches long, 5¾ inches wide, and 6 inches high. It weighs 13 pounds and contains TNT.

Comments: The test history of this item is not known. The device appears to be effective.

Reference: Report EODS-65-3, Viet Cong's Explosive Ordnance Used in South Vietnam, U. S. Naval School, Explosive Ordnance Disposal, Jul 1965, page 63.

81mm MORTAR CONTAINER MINE

28-35

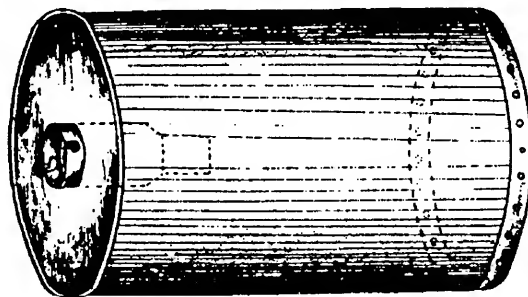

Description: This mine is constructed of an 81mm mortar shell container with the cap intact and the bottom plugged with a round piece of wood of the same diameter, $\frac{5}{8}$ inches thick. An electric blasting cap or friction fuse can be utilized with this mine. In the friction fuse, a brass friction wire is pulled through a black powder charge.

Comments: The test history of this item is not known. The device appears to be effective.

Reference: Report EODS-65-3, Viet Cong's Ordnance Used in South Vietnam, U. S. Naval School, Explosive Ordnance Disposal, Jul 1965, page 64.

VIET CONG ROUND VOLUME MINE

28-36

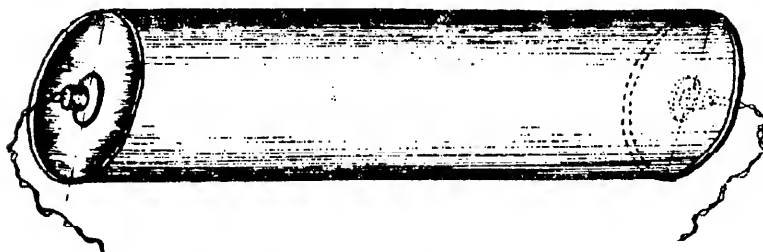

Description: This locally manufactured mine is constructed of sheet metal and is fired electrically. There are two detonators located in the head of the mine, one on each end. The mine is 5 inches in diameter and 17 inches long. It weighs 15 pounds and contains 13 pounds of Melinite explosive.

Comments: The test history of this item is not known. The device appears to be effective.

Reference: Report EODS-65-3, Viet Cong's Ordnance Used in South Vietnam, U. S. Naval School, Explosive Ordnance Disposal, Jul 1965, page 65.

Section 29. OTHER EXPLOSIVE ORDNANCE

PIPE HAND GRENADE

29-1

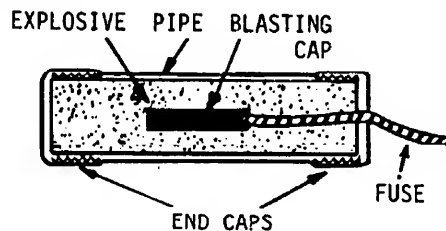

Description: A hand grenade can be improvised from a piece of iron pipe, pipe caps, explosive filler, a nonelectric blasting cap, and fuse cord. These components are prepared separately and then assembled to form the grenade. The grenade is initiated by lighting the fuse cord that ignites the blasting cap. The cap detonates the explosive filler. A hand drill and pliers are required in the preparation and assembly processes. The size of the device ranges from 1½ to 3 inches diameter and 3 to 8 inches long.

Comments: This item was tested. It is effective.

Reference: TM 31-210, Improvised Munitions, sec II, No. 1.

NAIL GRENADE

29-2

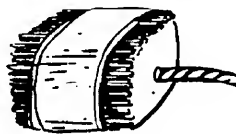

Description: An effective fragmentation grenade can be made from TNT or other blasting explosive, and some nails. A nonelectric blasting cap, fuse cord, and material for securing the nails to the explosive are used in constructing the device. The blasting cap is crimped on the fuse cord and inserted in the explosive. The explosive is surrounded by a layer of nails that are bound or taped into place. The grenade

is initiated by lighting the fuse cord that ignites the blasting cap. The cap detonates the explosive filler. Upon detonation, the nails will be scattered.

Comments: This item was tested. It is effective.

Reference: TM 31-210, Improvised Munitions, sec II, No. 2.

BRITISH CLAM, MK III

29-3

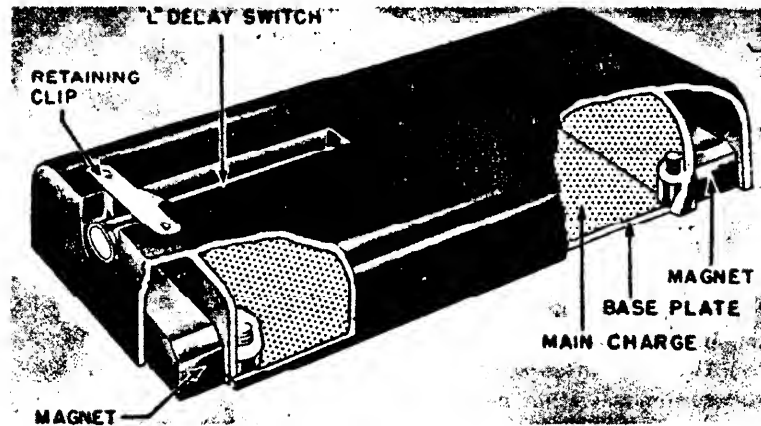

Description: The Clam is a small time bomb with a magnetic base that enables it to be attached to any flat iron or steel surface, such as engine blocks or railroad tracks. It measures $5\frac{3}{4}$ by $2\frac{3}{4}$ by $1\frac{1}{2}$ inches high. At each end is a magnet compartment in which two magnets are loosely mounted so that they can grip an uneven surface. The center portion contains about 8 ounces of high explosive, usually tetryl/TNT, 45/55. A Delay Switch No. 9, MK I with a Detonator No. 27 attached, serves as the delay initiator.

Comments: The test history of this item is not known. The device is presumed to be effective.

Reference: (C) TM 9-1985-1, British Explosive Ordnance (U), page 447.

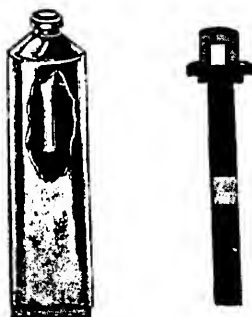

Description: The "tube of toothpaste" is an unpainted tin tube, 7 inches long and 2 inches wide. It contains an explosive consisting of 80 percent RDX and a 20 percent mixture of mineral oil and wax. Total explosive weight is 4.2 ounces. An ignition device (right view), that consists of an igniter and a match head, is packed separately. For operation, the screw cap on top of the tube is removed and the ignition device is inserted. The safety cap is then removed and the match composition is struck against a rough surface.

Comments: The test history of this item is not known. The device is presumed to be workable.

Reference: TM 9-1985-4, Japanese Explosive Ordnance, page 258.

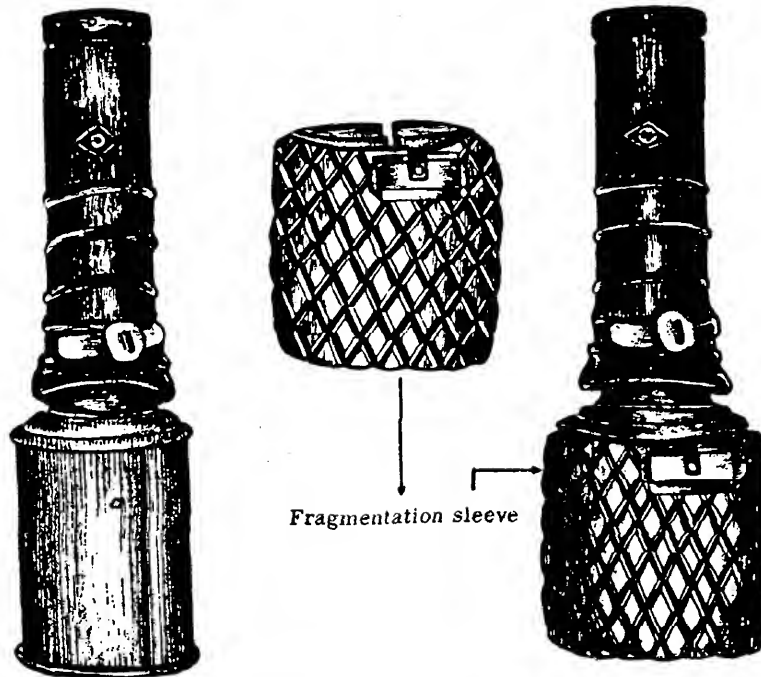

Description: The RGD-33 offensive and defensive hand grenade is a dual-purpose grenade. As an offensive grenade, it has a 5.5 yard lethal radius. By adding a fragmentation sleeve, it becomes a defensive grenade, which has a 27 yard lethal radius. This sheet metal grenade is normally painted olive brown. The grenade is 2 inches in diameter and 7½ inches long. It weighs 1½ pounds. The grenade is thrown vigorously. A spring in the handle forces the body back quickly and the firing pin strikes the primer actuating the delay element. The grenade detonates in 3-4 seconds.

Comments: The test history of this item is not known. The device appears to be effective.

Caution: Duds are dangerous and should be destroyed in place, as the slightest vibration may set them off.

Reference: Report EODS-65-3, Viet Cong's Explosive Ordnance Used in South Vietnam, U. S. Naval School, Explosive Ordnance Disposal, Jul 1965, page 19.

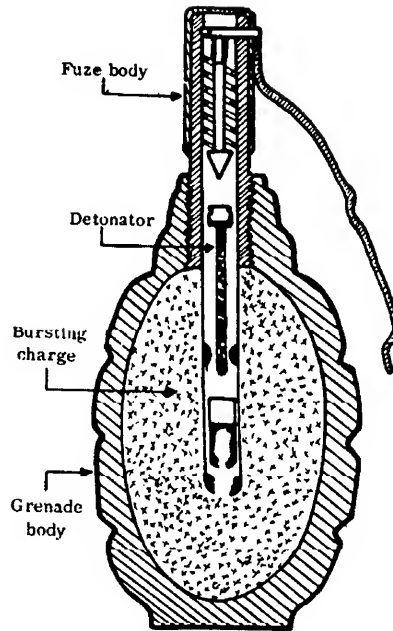

Description: The shape and operation of this F.1 hand grenade are similar to those of the US Mk 2 grenade. Its case is of serrated cast iron and painted olive drab. It is an antipersonnel grenade weighing $1\frac{1}{2}$ pounds. It is $2\frac{1}{4}$ inches in diameter and 5 inches long. The effective fragmentation radius is 15 yards. When thrown, the safety lever of the grenade springs up, loosening the spring of the firing pin that ignites the primer, burns the time fuze (3-5 seconds), and explodes the grenade.

Comments: The test history of this item is not known. The device appears to be effective.

Reference: Report EODS-65-3, Viet Cong's Explosive Ordnance Used in South Vietnam, U. S. Naval School, Explosive Ordnance Disposal, Jul 1965, page 21.

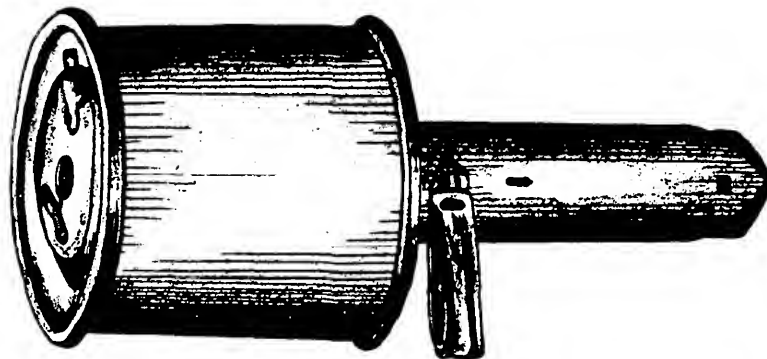

Description: This grenade is used mainly against light armored vehicles. It is made of sheet metal and contains TNT. It is $3\frac{1}{2}$ inches in diameter and 8 inches long. It weighs $2\frac{3}{4}$ pounds. The effective fragmentation radius is 22 yards. A detonator is inserted into the grenade before the grenade is thrown. The igniting device is placed inside the handle that is tightly screwed into the top of the grenade. When the safety pin is removed and the safety lever released, the grenade is in the armed position. It fires on impact without delay.

Comments: The test history of this item is not known. The device appears to be effective.

Caution: Under no circumstances should dud grenades of this type be picked up, as the fuze is armed and the slightest vibration will set it off.

Reference: Report EODS-65-3, Viet Cong's Explosive Ordnance Used in South Vietnam, U. S. Naval School, Explosive Ordnance Disposal, Jul 1965, page 23.

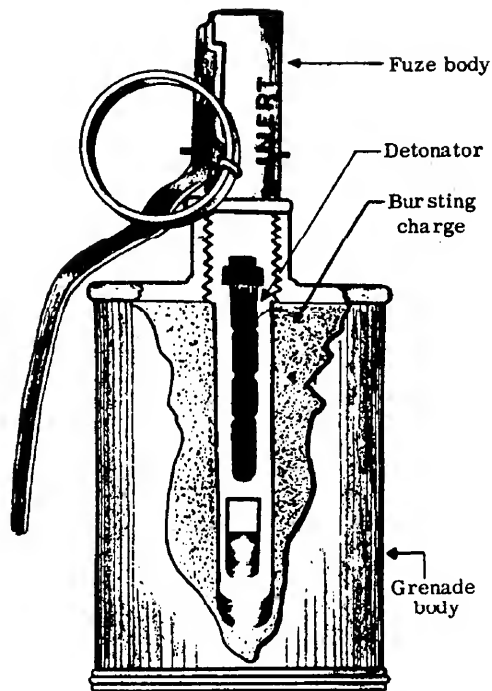

Description: This antipersonnel grenade has a sheet metal cylindrical body that contains 100 gm TNT. It is $2\frac{1}{4}$ inches in diameter and 5 inches long. It weighs 14 ounces. When the grenade is thrown, the safety lever will spring upward and leave the grenade body. The firing pin is forced down and strikes the primer that ignites the time fuze (3-4 seconds) and sets off the grenade.

Comments: The test history of this item is not known. The device appears to be effective.

Reference: Report EODS-65-3, Viet Cong's Explosive Ordnance Used in South Vietnam, U. S. Naval School, Explosive Ordnance Disposal, Jul 1965, page 25.

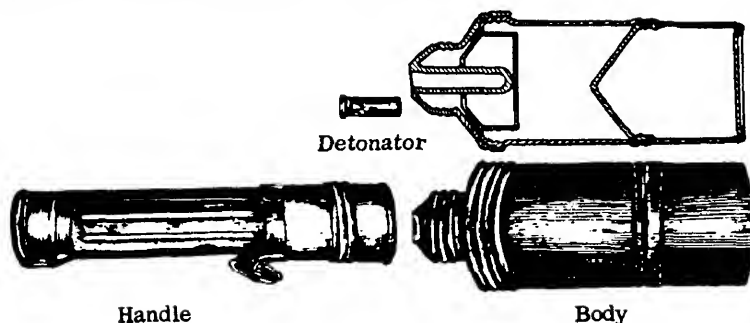

Description: This grenade is used against tanks, armored personnel carriers, blockhouses, and vessels. The parachute stabilizes the grenade. It explodes at a low impact angle and has approximately the same effect as a HEAT round. It will penetrate 5 inches steel. The grenade is made of tin and is cylindrical in shape. The charge is cast TNT. Overall length is 15 inches and weight 2½ pounds. The grenade is made up of three separate components: body, fuze, and handle. They are assembled just before use. The handle (2 inches diameter) contains firing pin, safety pin, and parachute. The body (3 inches diameter) contains the shaped charge. When thrown, the spring ejects a parachute holding cap (at the head of the handle) to the rear and a recoil spring ejects the parachute out of the handle. Upon impact, the inertia-activated firing pin moves forward, strikes the detonator, and detonates the grenade.

Comments: The test history of this item is not known. The device appears to be effective. The grenade is believed to be a Russian product.

Caution: Duds must never be touched because they may explode unexpectedly.

Reference: Report EODS-65-3, Viet Cong's Explosive Ordnance Used in South Vietnam, U. S. Naval School, Explosive Ordnance Disposal, Jul 1965, page 27.

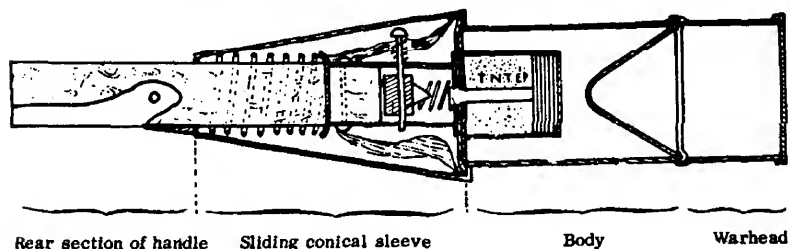

Description: This grenade is used against tanks and armored personnel carriers. The parachute stabilizes the grenade and assures proper impact angle at the target. It pierces up to 4 inches of steel. The grenade is made of sheet iron and a wooden handle. The charge is cast TNT. Overall length is 13½ inches and weighs 1½ pounds. The grenade is made up of four parts: handle, conical sleeve, body, and warhead. The cone houses firing pin, safety pin, and parachute. The body (3 inches diameter) contains a detonator and the shaped charge while the warhead provides the stand-off. When thrown, the spring pulls the parachute cone to the rear and the parachute deploys. At the same time, the safety pin is pulled out of the grenade. Upon impact, the firing pin strikes the detonator and explodes the grenade.

Comments: The test history of this item is not known. The device appears to be effective.

Caution: Duds must never be touched because they may explode unexpectedly.

Reference: Report EODS-65-3, Viet Cong's Explosive Ordnance Used in South Vietnam, U. S. Naval School, Explosive Ordnance Disposal, Jul 1965, page 29.

RUSSIAN HAND GRENADE, RPG-6

29-11

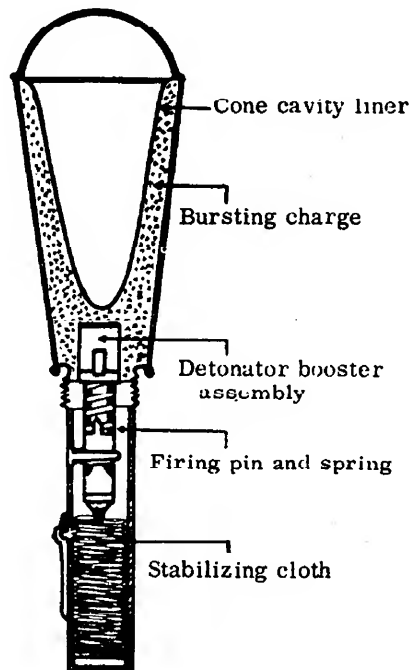

Description: This antitank hand grenade, RPG-6, is a shaped charge grenade that can be used against personnel because of its effective fragmentation radius (22 yards). It is 13½ inches long and weighs 2½ pounds. When thrown, the grenade is balanced by four pieces of parachute cloth that eject from the handle as the safety lever is ejected. The grenade explodes on impact. Unlike the RPG-3 grenade, this type of grenade has a crescent shaped head and its handle is made of sheet metal instead of wood.

Comments: The test history of this item is not known. The device appears to be effective.

Reference: Report EODS-65-3, Viet Cong's Explosive Ordnance Used in South Vietnam, U. S. Naval School, Explosive Ordnance Disposal, Jul 1965, page 31.

RUSSIAN HAND GRENADE, RPG-43

29-12

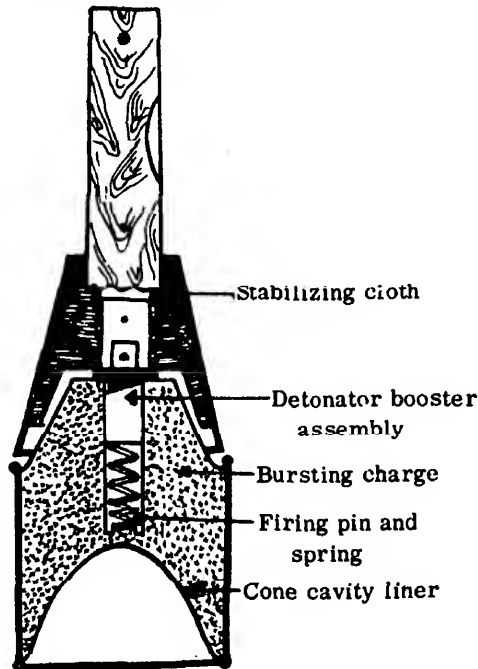

Description: The RPG-43 hand grenade is an antitank hand grenade used to attack armored cars and fortified defensive positions. It penetrates 3 inches steel. It is 12 inches long and weighs 2¾ pounds. The grenade equilibrium device consists of two pieces of cloth and a steel cone. The grenade will explode upon striking the target. It is charac-

terized by a large cylindrical body, wooden handle, and steel parachute cone.

Comments: The test history of this item is not known. The device appears to be effective.

Reference: Report EODS-65-3, Viet Cong's Explosive Ordnance Used in South Vietnam, U. S. Naval School, Explosive Ordnance Disposal, Jul 1965, page 33.

CHAPTER 30. SMALL ARMS

Section 31. BALLISTICS AND PENETRATION

EXTERIOR BALLISTICS OF STANDARD SMALL-ARMS CARTRIDGES 31-1

Description: Exterior ballistics deals with the motion of projectiles after they leave the weapon. The two important aspects of this motion are velocity (speed of projectile to target) and accuracy (closeness to desired point of impact). Velocity and accuracy data of standard U.S. small-arms cartridges are listed in the table below. Velocity (at the muzzle) is given in feet per second and accuracy as an average radius of dispersion (in inches) from the center of target impact.

Caliber	Cartridge		Velocity (fps)	Accuracy	
	no.	type*		Target dist. (yd)	Mean rad. (in.)
Cal .30	M1	I	2950	600	15
	M1	T	2700		18
	M2	AP	2715		10
	M2	Ball	2740		7.5
	M14A1	AP,I	2780		9
	M25	T	2665		18
	M72	Match	2640		3.5
Cal .30	M1	Ball	1900	100	1.5
Carbine	M16	T	1850		3.5
	M27	T	1800		3.5
7.62mm	M59	Ball	2750	600	7.5
	M61	AP	2750		7.5
	M62	T	2750		12
	M80	Ball	2750		10
Cal .45	M1911	Ball	820	50	2
	M26	T	850		5
Cal .50	M1	I	2950	600	12
	M1	T	2700		20
	M2	AP	2900		8
	M2	Ball	2810		9
	M8	AP,I	2910		12
	M10	T	2860		20
	M17	T	2860		20
	M20	AP,I,T	2910		12
	M21	T	2840		20

Caliber	Cartridge		Velocity (fps)	Accuracy	
	no.	type*		Target dist. (yd)	Mean rad. (in.)
20mm	M33	Ball	2910		12
	M48	S,T	1850		10
	M48A1	S,T	1745		5
	M53	AP,I	3250	600	15
	M55A1	Ball	3250		15
	M56A1	HE,I	3250		20
	M95	AP,I	2680		15
	M96	I	2710		15
	M99	TP	2680		15

*Type code: AP=Armor piercing S =Spotting
HE=High explosive T =Tracer
I =Incendiary TP=Target practice

Comments: These data were obtained by test. They are valid.

Reference: Small Arms Ammunition Reference Manual, Frankford Arsenal, Jun 1960.

Section 32. WEAPONS

PIPE PISTOL FOR 9mm AMMUNITION

32-1

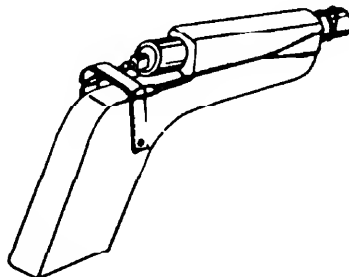

Description: A 9mm pistol can be made from 1/4-inch steel gas or water pipe and pipe fittings. Other materials used in its construction include metal strip, elastic bands, a flat head nail, wood screws, and a block of hard wood. A drill is required for cutting holes in various parts during fabrication and assembly of the weapon. A wood or metal rod is used to remove the cartridge case from the pistol.

Comments: This weapon has been tested. It is effective. After assembling the weapon, it should be test fired from a safe position before firing by hand.

Reference: TM 31-210, Improvised Munitions, sec III, No. 1.

SHOTGUN (12 GAUGE)

32-2

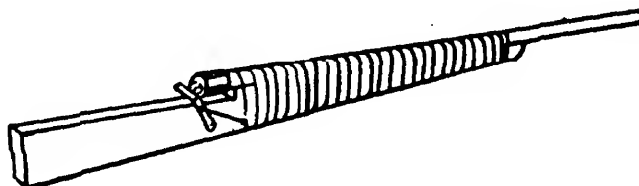

Description: A 12-gauge shotgun can be made from $\frac{3}{4}$ -inch steel gas or water pipe and pipe fittings. Other materials used in its construction include metal strip, elastic bands, a flat head nail, wood screws, heavy twine, shellac or lacquer, and a length of hard wood. A drill, file, and saw or knife are required for fabrication and assembly of the weapon.

Comments: This weapon was tested. It is effective. After assembling the weapon, it should be test-fired from a safe position before firing by hand.

Reference: TM 31-210, Improvised Munitions, sec III, No. 2.

MODIFIED AV-34 AIRCRAFT MACHINE GUN

32-3



Description: This weapon originally was a French 7.5mm Model AV-34 flexible aircraft machine gun. A handguard and a shoulder stock salvaged from a Chatellerault Model 24/29 automatic rifle were added. The rear sight appears to be a survivor of the Franco-Prussian War.

Comments: The test history of this item is not known. The weapon is presumed to be effective.

Reference: (C) FSTC 381-5012, Typical Foreign Unconventional Warfare Weapons (U), Army Materiel Command, Sep 1964, page 12.

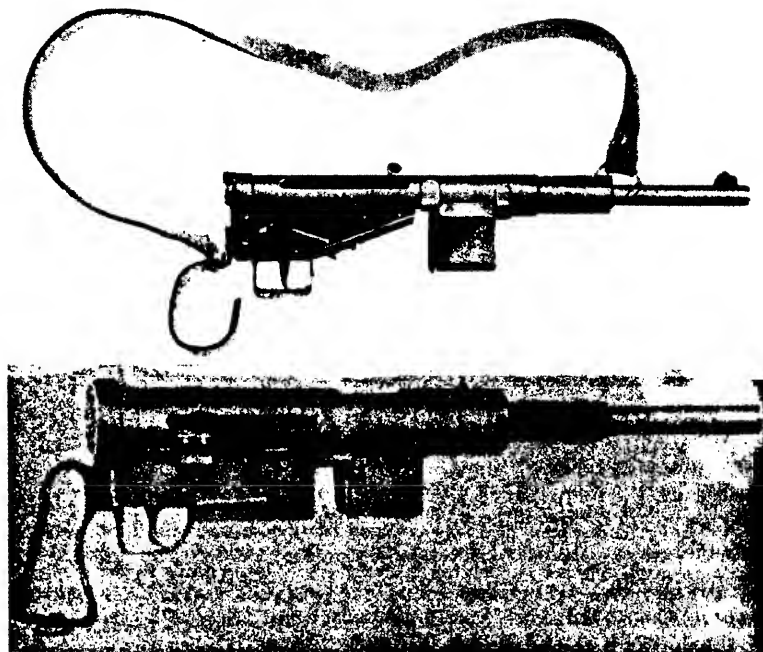

Description: The United Kingdom's Sten-series submachine gun is one of the most widespread weapons of its type in the world, and it has been copied in varying degrees by many countries. The weapons shown above were made in Vietnam and are styled after the MK-11 Sten gun. The pistol grips of each were probably modified from British manufactured recoil spring cap and buttstock assemblies. The receivers are definitely not Sten parts because the magazine housings are attached to the bottoms of the receivers. On a Sten weapon this housing is fastened on the left side of the receiver.

Comments: The test history of these items is not known. The weapons are presumed to be effective.

Reference: (C) FSTC 381-5012, Typical Foreign Unconventional Warfare Weapons (U), Army Materiel Command, Sep 1964 pages 10 and 11.



Description: This item is essentially a blowback-operated pistol without the magazine. It is composed of a piece of pipe or of a thick walled tube that is fastened to a wooden grip assembly by two sheet-metal straps. The pistol is operated by pulling back on the machine screw on top until the bolt latches to the rear. A cartridge is placed into the chamber through the loading port in the right side of the receiver. The weapon is fired from the open bolt position. The spent case is extracted by shaking or prying because neither extractor nor ejector is provided.

Comments: The test history of this item is not known. The weapon is presumed to be effective.

Reference: (C) FSTC 381-5012, Typical Foreign Unconventional Warfare Weapons (U), Army Materiel Command, Sep 1964, page 4.



Description: The barrel of this weapon is made of two pieces of pipe held together by pins. The grip is a length of wire bent into shape and attached to the receiver either by welding or riveting. The pistol is loaded by retracting the bolt handle and engaging it in a small vertical slot. The cartridge is then placed into the chamber through the loading port located on the side of the receiver. To fire the weapon, the bolt handle is disengaged from the vertical slot. The compressed driving spring forces the bolt forward until the firing pin strikes the primer.

Comments: The test history of this item is not known. The weapon is presumed to be effective.

Reference: (C) FSTC 381-5012, Typical Foreign Unconventional Warfare Weapons (U), Army Materiel Command, Sep 1964, pages 4 and 5.

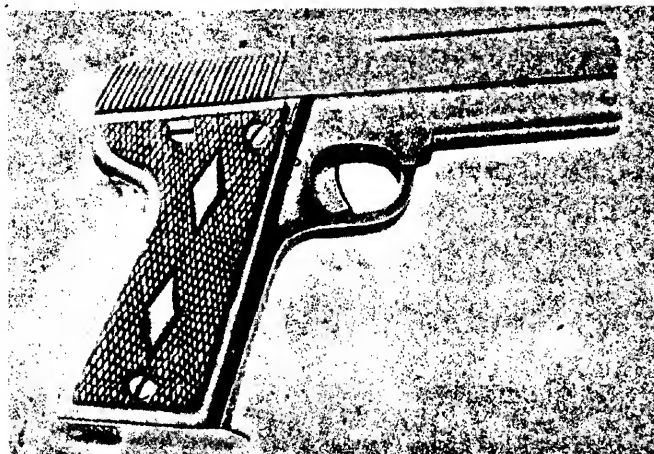

Description: This caliber .32 semiautomatic pistol exhibits considerable ingenuity on the part of its creator because of the difficulties overcome in manufacturing it. It is completely hand made. A skilled guerrilla does not hesitate to produce a copy of a proven weapon, especially when a specimen is available.

Comments: The test history of this item is not known. The weapon is presumed to be effective.

Reference: (C) FSTC 381-5012, Typical Foreign Unconventional Warfare Weapons (U), Army Materiel Command, Sep 1964, pages 5 and 6.



Description: The barrel and receiver of this shotgun are made from a piece of pipe that is fastened to the stock by a metal strap and a metal block. The metal block also serves as a recoil shoulder. The trigger pivots about a screw that passes transversely through the stock. In this respect the trigger mechanism resembles that of a British Lee-Metford and Lee-Enfield rifle.

Comments: The test history of this item is not known. The weapon is presumed to be effective.

Reference: (C) FSTC 381-5012, Typical Foreign Unconventional Warfare Weapons (U), Army Materiel Command, Sep 1964, pages 7 and 8.

VIET CONG MODIFIED MANNLICHER-BERTHIER RIFLE

32-9

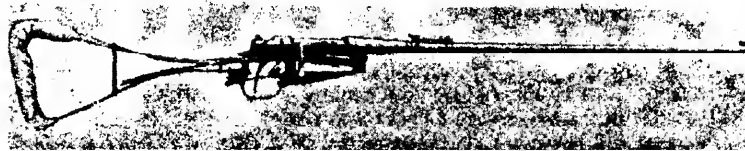

Description: This weapon is a modified French 8mm Model 1907/15 Mannlicher-Berthier rifle. The modification in this instance may have been to return the weapon to useable condition or to adapt it to the individual ideas of its user.

Comments: The test history of this item is not known. The weapon is presumed to be effective.

Reference: (C) FSTC 381-5012, Typical Foreign Unconventional Warfare Weapons (U), Army Materiel Command, Sep 1964, pages 7 and 8.

VIET CONG MODIFIED GRAS RIFLE

32-10



Description: This weapon is a converted French 11mm Model 1874 Gras rifle. Since ammunition for this weapon is almost nonexistent, the barrel was cut off to make the weapon easier to handle, and the chamber was modified slightly so that .410-gauge shotgun shells could be fired. The stock is homemade.

Comments: The test history of this item is not known. The weapon is presumed to be effective.

Reference: (C) FSTC 381-5012, Typical Foreign Unconventional Warfare Weapons (U), Army Materiel Command, Sep 1964, pages 8 and 9.

VIET CONG MODIFIED M1917 ENFIELD RIFLE

32-11

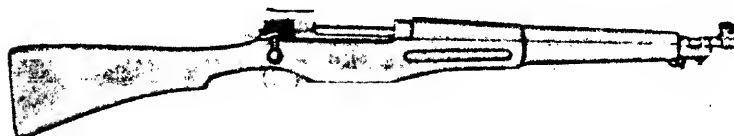

Description: The barrel and stock of this U.S. Caliber .30 M1917 Enfield rifle have been cut down and the front sight has been remounted to produce a lighter weapon that can be swung into firing position more rapidly, especially in the dense undergrowth found in Vietnam.

Comments: The test history of this item is not known. The weapon is presumed to be effective.

Reference: (C) FSTC 381-5012, Typical Foreign Unconventional Warfare Weapons (U), Army Materiel Command, Sep 1964, page 9.

VIETNAMESE COPY OF 9mm BROWNING PISTOL

32-12



Description: This 9mm pistol was, according to the markings in the slide, manufactured at the Allied National Army Military Manufactory Number 5, which was located near Tay Ninh. It is a copy of the NATO Hi-Power pistol. The pistol is semiautomatic, weighs 2 pounds is $7\frac{3}{4}$ inches long, and has a doubleline magazine that holds 13 cartridges.

Comments: The test history of this item is not known. The weapon is presumed to be effective.

Reference: (C) FSTC 381-5012, Typical Foreign Unconventional Warfare Weapons (U), Army Materiel Command, Sep 1964, pages 5 and 6.

VIET CONG ROCKET LAUNCHER

32-13

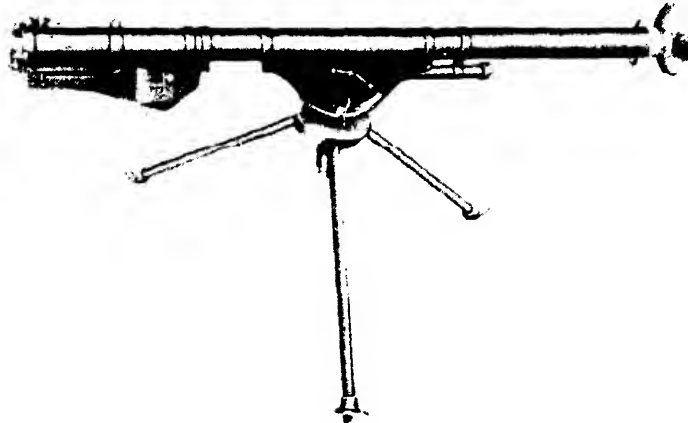

Description: This weapon is a variation of the Model S.S.A. recoilless gun. It is a 60mm, smooth bore weapon, approximately $4\frac{1}{2}$ ft long. It differs in being a rocket launcher and in having a sector plate and a wingnut on the mount to provide elevation adjustment. It is a breech loaded weapon and fires electrically initiated ammunition.

Comments: The test history of this item is not known. The weapon is presumed to be effective.

Reference: (C) FSTC 381-5012, Typical Foreign Unconventional Warfare Weapons (U), Army Materiel Command, Sep 1964, page 13.

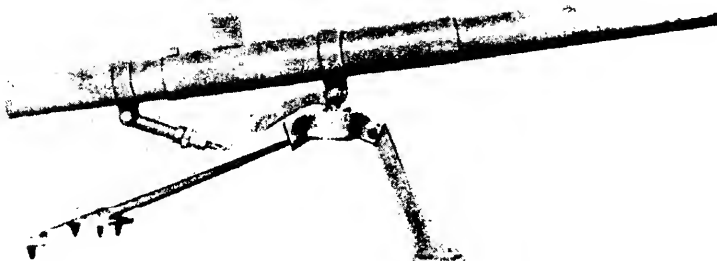

Description: The model S.S.A. recoilless gun was made either in North Vietnam or in a Viet Cong safe area because its manufacture requires fairly extensive machine shop facilities. The tube is a 60mm smooth bore made of a piece of pipe approximately 4½ feet long. It employs a V-notch and blade sighting system mounted on a reinforcing sleeve. The circular clamp surrounding the barrel has a tapered pin pivoted to its bottom for attaching the tube to the tripod. The weapon traverses freely, but elevation is accomplished by means of a threaded shaft extending from a clamp around the rear of the tube to an arm attached to the mounting clamp. The total weight of the weapon is approximately 72 pounds.

Comments: The test history of this item is not known. The weapon is presumed to be effective.

Reference: (C) FSTC 381-5012, Typical Foreign Unconventional Warfare Weapons (U), Army Materiel Command, Sep 1964, pages 12 and 13.

VIETNAMESE CIGARETTE LIGHTER

32-15

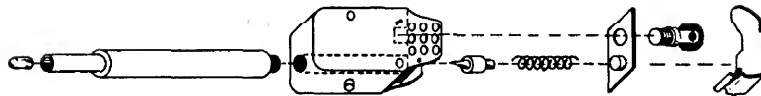
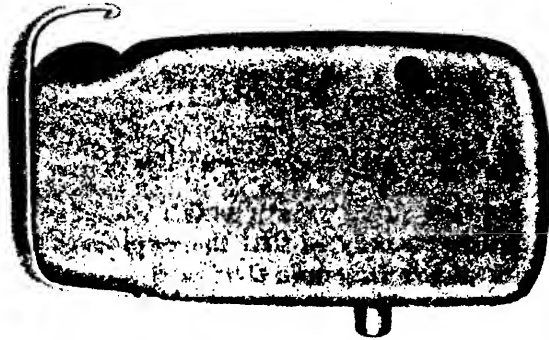

Description: This item is actually a firearm that was probably made for an assassination mission. The body of the lighter houses a tube containing the functional parts. The working parts of this item are shown in the exploded view.

Comments: The test history of this item is not known. The weapon is presumed to be effective. This weapon is primarily a short range device. The user probably could not hit a man-size target beyond 10 feet.

Reference: (C) FSTC 381-5012, Typical Foreign Unconventional Warfare Weapons (U), Army Materiel Command, Sep 1964, pages 42 and 43.

VIET CONG SUBMACHINE GUN

32-16

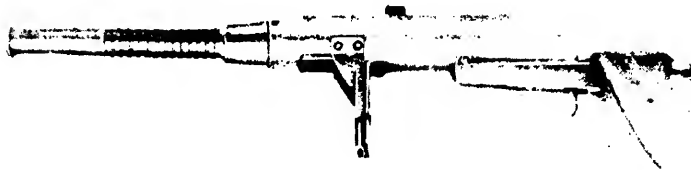

Description: This weapon has a barrel and receiver assembly made of pipe, with various pieces held together by pins. The grip frame has been made from iron strap, and is welded to the receiver. The trigger-group and magazine-housing assemblies, also welded to the receiver, evidently have been salvaged from a standard submachine gun of unknown origin.

Comments: The test history of this item is not known. The weapon is presumed to be effective.

Reference: (C) FSTC 381-5012, Typical Foreign Unconventional Warfare Weapons (U), Army Material Command, Sep 1964, pages 9 and 10.

VIETNAMESE PINFIRE SHOTGUN

32-17



Description: This "rifle" is a smooth-bore weapon having a barrel made from a piece of pipe. The hammer arrangement suggests that the gun employs pinfire cartridges. The breechblock pivots on a common door hinge. The absence of the trigger indicates that the weapon is fired by pressing down on the hammer spur to compress the hammer spring. The cartridge is initiated when release of the hammer spur permits the hammer to strike the primer.

Comments: The test history of this item is not known. The weapon is presumed to be effective.

Reference: (C) FSTC 381 5012, Typical Foreign Unconventional Warfare Weapons (U), Army Materiel Command, Sep 1964, page 7.

VIET CONG FOUNTAIN PEN WEAPON

32-18

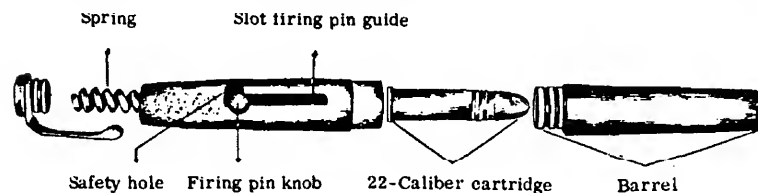

Description: This weapon has the shape of an ordinary fountain pen with a fastening clip. It is 5 inches long, 1/2 inch in diameter, and fires caliber .22 bullets. The pen body is made of a smooth, thin metal tube and the bore has no riflings. The weapon is employed at short range (5 feet). To load, the barrel is removed and the cartridge is inserted. The operating handle is pulled to the rear and turned left until it engages in the safety lock to cock the weapon. When the operating handle is turned right, it disengages from the safety pin and pushed the firing pin forward (by force of the spring) that strikes the primer and fires the weapon.

Comments: The test history of this item is not known. The device appears to be effective.

Reference: Report EODS-65-3, Viet Cong's Explosive Ordnance Used in South Vietnam, U. S. Naval School, Explosive Ordnance Disposal, Jul 1965, page 1.

Section 33. AMMUNITION

SHOTSHELL DISPERSION CONTROL

33-1

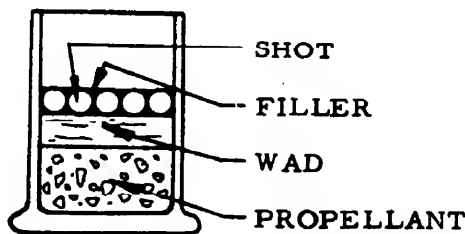

Description: A tighter target dispersion of shotgun pellets can be achieved by changing from random distribution of the pellets to a layer-on-layer pattern in the cartridge. The pellets are first removed and then placed in the cartridge in layers. Filler material is poured into the cartridge to fill the space between the pellets as each layer is added. This process is repeated until all the pellets have been replaced. The cartridge is then reprimed and the end sealed with wax. The shot spread is approximately two-thirds that of a standard cartridge.

Comments: This item was tested. It is effective.

Reference: TM 31-210, Improvised Munitions, sec III, No. 3.

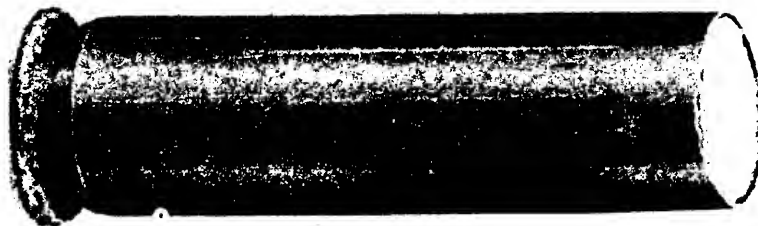

Description: This 12 gauge shot shell is improvised from a U.S. Caliber .50 machinegun cartridge. It is fashioned by disassembling a loaded round and cutting the cartridge case to length. The head of the case is modified by peening the extractor flange into a rim and filing the rim to the correct diameter. The finished case is then loaded with propellant, wadding, shot or scrap metal, and more wadding. The end is then sealed with paraffin or candle wax.

Comments: The test history of this item is not known. The item is presumed to be effective.

Reference: (C) FSTC 381-5012, Typical Foreign Unconventional Warfare Weapons (U), Army Materiel Command, Sep 1964, page 3.

CHAPTER 40. HARMFUL ADDITIVES— CHEMICAL MATERIALS

Section 41. CORROSIVE MATERIALS

AMYL PHOSPHORIC ACID

41-1

Description: Amyl phosphoric acid is an alkylated derivative of phosphoric acid, a strong inorganic acid. It was evaluated as a corrosive for engine bearings. The volume proportions were 3 percent additive and 97 percent lubricating oil. The bearings in the test engine were of the following materials: crankshaft bearing, babbitt, steel backed; main bearing, hi-lead bronze, steel backed; connecting rod bearing, machined aluminum.

Comments: This material was tested. It was effective. Tests were conducted using a special laboratory test engine. Using 3 percent additive, the engine ran out of gasoline after 17 hours of operation. When the engine was dismantled, the connecting rod bearing stuck and the other bearings and oil pump were tight. The piston rings were fouled and the piston was tight in the cylinder. The connecting rod bearing was etched and the main bearing was attacked. Using 1 percent amyl phosphoric acid, the engine was stopped after 6 hours and allowed to cool. The engine then could not be started. The connecting rod bearing stuck, the main bearing was tight and the piston rings were fouled.

Reference: NRL Report P-1954, Sabotage Agents for Use in Lubricants and Fuel for Internal Combustion Engines, H. R. Baker and C. M. Murphy, Naval Research Laboratory, Oct 30, 1942.

DICHLORONITROPROPANE

41-2

Description: Dichloronitropropane is a chlorinated and nitrated derivative of propane, a gas obtained from petroleum. It was evaluated as a corrosive for engine bearings. The volume proportions were 3 percent additive and 97 percent lubricating oil. The bearings in the test engine were of the following materials: crankshaft bearing, babbitt, steel backed; main bearing, hi-lead bronze, steel backed; connecting rod bearing, machined aluminum.

Comments: This material was tested. It was not effective. Tests were conducted using a special laboratory test engine. There was no effect on the engine operation and no corrosive attack on the bearings.

Reference: Same as 41-1.

PARAFFIN WAX SULFONYL CHLORIDE**41-3**

Description: Paraffin wax sulfonyl chloride is the acid chloride of sulfonated paraffin wax, a mixture of alkanes obtained from petroleum. It was evaluated as a corrosive for engine bearings. The volume proportions were 3 percent additive and 97 percent lubricating oil. The bearings in the test engine were of the following materials: crankshaft bearing, babbitt, steel backed; main bearing, hi-lead bronze, steel backed; connecting rod bearing, machined aluminum.

Comments: This material was tested. It was not effective. Tests were conducted using a special laboratory test engine. There was no effect on the engine operation and no corrosive attack on the bearings.

Reference: Same as 41-1.

NITROBENZENE**41-4**

Description: Nitrobenzene, also called oil of mirbane, is a light yellow liquid used as an organic solvent. It was evaluated as a corrosive for engine bearings. The volume proportions were 3 percent additive and 97 percent lubricating oil. The bearings in the test engine were of the following materials: crankshaft bearing, babbitt, steel backed; main bearing, hi-lead bronze, steel backed; connecting rod bearing, machine aluminum.

Comments: This material was tested. It was not effective. Tests were conducted using a special laboratory test engine. There was no effect on the engine operation and no corrosive attack on the bearings.

Reference: Same as 41-1.

o-DICHLOROBENZENE**41-5**

Description: o-Dichlorobenzene is a high-boiling colorless liquid used as an organic solvent. It was evaluated as a corrosive for engine bearings. The volume proportions were 3 percent additive and 97 percent lubricating oil. The bearings in the test engine were of the following materials: crankshaft bearing, babbitt, steel backed; main bearing, hi-lead bronze, steel backed; connecting rod bearing, machined aluminum.

Comments: This material was tested. It was not effective. Tests were conducted using a special laboratory test engine. There was no effect on the engine operation and no corrosive attack on the bearings.

Reference: Same as 41-1.

BUTANE SULFONYL CHLORIDE**41-6**

Description: Butane sulfonyl chloride is the acid chloride of sulfonated butane, a low molecular weight gas obtained from petroleum. It was evaluated as a corrosive for engine bearings. The volume proportions were 3 percent additive and 97 percent lubricating oil. The bearings

in the test engine were of the following materials: crankshaft bearing, babbitt, steel backed; main bearing, hi-lead bronze, steel backed; connecting rod bearing, machined aluminum.

Comments: This material was tested. It was not effective. Tests were conducted using a special laboratory test engine. There was no effect on the engine operation and no corrosive attack on the bearings.

Reference: Same as 41-1.

BROMOBENZENE

41-7

Description: Bromobenzene is a chemical used in organic synthesis. It was evaluated as a corrosive for engine bearings. The volume proportions were 3 percent additive and 97 percent lubricating oil. The bearings in the test engine were of the following materials: crankshaft bearing, babbitt, steel backed; main bearing, hi-lead bronze, steel backed; connecting rod bearing, machined aluminum.

Comments: This material was tested. It was not effective. Tests were conducted using a special laboratory test engine. There was no effect on the engine operation and no corrosive attack on the bearings.

Reference: Same as 41-1.

GLYCEROLDICHLOROHYDRIN

41-8

Description: Glyceroldichlorohydrin is a chemical used in organic synthesis. It was evaluated as a corrosive for engine bearings. The volume proportions were 3 percent additive and 97 percent lubricating oil. The bearings in the test engine were of the following materials: crankshaft bearing, babbitt, steel backed; main bearing, hi-lead bronze, steel backed; connecting rod bearing, machined aluminum.

Comments: This material was tested. It was not effective. Tests were conducted using a special laboratory test engine. There was no effect on the engine operation and no corrosive attack on the bearings.

Reference: Same as 41-1.

Section 42. ABRASIVE MATERIALS

QUARTZ DUST

42-1

Description: Pulverized quartz was evaluated as an abrasive for standard diesel fuel. Addition of 0.005% by weight of quartz dust in the fuel used in an air-injection engine (1 cylinder, 4 cycle, 50 hp) resulted in six times as much wear as normally. Addition of 0.01% by weight quartz dust resulted in nine times the engine wear.

Comments: This material was tested. It was effective.

Reference: S.A.E. Journal, Vol. 38, No. 5, Cylinder Wear in Diesel Engines, G. D. Boerlage and B. J. J. Gravesteyn, May 1963, pages 197 through 199.

IRON NAPHTHENATE

42-2

Description: Iron naphthenate is the iron derivative of naphthenic acid. It was evaluated as an abrasive for standard diesel fuel. Addition of 0.05% by weight to the fuel of an air-injection diesel engine (1 cylinder, 4 cycle, 50 hp) resulted in engine wear three times greater than normal.

Comments: This material was tested. It was effective. Oil was fed to the cylinder at the rate of about 60 gm per $\frac{1}{2}$ hour of which about 50 gm was collected in a crucible for the determination of its ash content. Ash content is a measure of cylinder wear.

Reference: Same as 42-1.

LEAD NAPHTHENATE

42-3

Description: Lead naphthenate is the lead derivative of naphthenic acid. It was evaluated as an abrasive for standard diesel fuel. In tests of short duration, additions of 0.035 and 0.06% by weight of lead naphthenate to the fuel of an air-injection diesel engine (1 cylinder, 4 cycle, 50 hp) did not change engine wear.

Comments: This material was tested. It was not effective. Oil was fed to the cylinder at the rate of about 60 gm per $\frac{1}{2}$ hour, of which about 50 gm was collected in a crucible for the determination of its ash content. Ash content is a measure of cylinder wear.

Reference: Same as 42-1.

COPPER NAPHTHENATE

42-4

Description: Copper naphthenate is the copper derivative of naphthenic acid. It was evaluated as an abrasive for standard diesel fuel. In tests of short duration, additions of 0.035 and 0.06% by weight of copper naphthenate to the fuel of an air-injection diesel engine (1 cylinder, 4 cycle, 50 hp) did not change engine wear.

Comments: This material was tested. It was not effective. Oil was fed to the cylinder at the rate of about 60 gm per $\frac{1}{2}$ hour, of which about 50 gm was collected in a crucible for the determination of its ash content. Ash content is a measure of cylinder wear.

Reference: Same as 42-1.

Section 43. CLOGGING MATERIALS

BENZENEDISULFONIC ACID—CASTOR OIL—ETHER

43-1

Description: Benzenedisulfonic acid is a corrosive organic acid. Castor oil is obtained from castor bean seeds. Ether is a flammable organic

solvent. The mixture was evaluated as a contaminant for lubricating oil. The weight proportions are summarized below.

Test no.	Benzenedisulfonic acid (gm)	Castor oil (gm)	Ether (cc)	Weight (%) added to oil
1	100	100	200	2.42
2	50	150	100	1.2

Comments: The mixture was tested. It was effective. Tests were conducted using Plymouth and Ford V-8 engines running at $\frac{1}{4}$, $\frac{1}{3}$, and full loads for $1\frac{3}{4}$ hours. The engine was very tight in both tests. There was a heavy varnish-like deposit on the cylinder wall, pistons, bearings and valve mechanisms indicating failure of the lubricating system. The oil pump screen was completely clogged. The pump had a large amount of rather hard flaky deposits.

Reference: Sabotaging Engines by Additions to the Lubricating Oil, T. A. Boyd, Ethyl Corporation, Final Report, Mar 11, 1943, Contract 283, OEMar-428.

STYRENE

43-2

Description: Styrene is an unsaturated organic chemical used for polymerizations. Two tests were run, one using styrene alone and one using styrene with an inhibitor. They were evaluated as contaminants for lubricating oil. The volume proportions were 3% additive and 97% lubricating oil.

Comments: The material was tested. It was effective. Tests were conducted using a special laboratory test engine. After one hour of operation, the engine developed a valve knock. When the engine was dismantled, the connecting rod bearing was badly scored and the main and cam shaft bearings were scratched. About half of the lubricant was consumed during the run. The interior of the engine was covered with a medium-heavy sludge deposit.

Reference: NRL Report P-1954, Sabotage Agents for Use in Lubricants and Fuel for Internal Combustion Engines, H. R. Baker and C. M. Murphy, Naval Research Laboratory, Oct 30, 1942.

GLACIAL ACETIC ACID

43-3

Description: Glacial acetic acid is a strong organic acid. It was evaluated as a contaminant for lubricating oil. The volume proportions were 1.0% additive and 99.0% lubricating oil.

Comments: This material was tested. It was partially effective. Tests were conducted using a Plymouth engine running at $\frac{1}{4}$ and full loads for 2 hours. Both rod bearings and main bearings lost 0.08 gm weight.

Reference: Same as 43-1.

BENZENEDISULFONIC ACID—ROSIN—ETHER**43-4**

Description: Benzenedisulfonic acid is a corrosive organic acid. Rosin is the hard part left over after distillation of turpentine. Ether is a flammable organic solvent. The following mixture was evaluated as a contaminant for lubricating oil: $33\frac{1}{3}$ gm benzenedisulfonic acid, $33\frac{1}{3}$ gm rosin and 200 cc ether. The weight proportions were 0.81% additive and 99.19% lubricating oil.

Comments: The mixture was tested. It was partially effective. Tests were conducted using a Plymouth engine running at $\frac{1}{4}$ and full loads for 1 hour. The engine was very tight immediately after shutting down. It could be turned with effort.

Reference: Same as 43-1.

p-TOLUENESULFONIC ACID—ACETONE**43-5**

Description: p-toluenesulfonic acid is a colorless solid that is used as an organic intermediate. Acetone is an organic solvent. The following mixture was evaluated as a contaminant for lubricating oil: 100 gm p-toluenesulfonic acid and 1000 cc acetone. The weight proportions were 2.4% additive and 97.6% lubricating oil.

Comments: This mixture was tested. It was partially effective. Tests were conducted using Plymouth and Ford V-8 engines running at $\frac{1}{4}$ and full loads for 2 hours. There was no effect on the Ford V-8 engine, but the Plymouth engine was fairly sticky with a heavy deposit on the surfaces in contact with the oil. All piston rings bound.

Reference: Same as 43-1.

ACETONE—BENZENEDISULFONIC ACID**43-6**

Description: Acetone is an organic solvent. Benzenedisulfonic acid is an acid used in organic synthesis. The following mixture was evaluated as a contaminant for lubricating oil: 150 cc acetone and 100 gm benzenedisulfonic acid. The volume proportions were 3.2% additive and 96.8% lubricating oil.

Comments: This compound was tested. It was partially effective. Tests were conducted using a Ford V-8 engine running at $\frac{1}{3}$ load for $\frac{1}{3}$ hour. It caused the engine to bind tightly. A black rubber-like deposit over a $\frac{1}{4}$ of the bearing area indicates that small quantities of this compound are effective for binding engines.

Reference: Same as 43-1.

**BENZENEDISULFONIC CHLORIDE—ETHER—TERTIARY
AMYL ALCOHOL—IODINE****43-7**

Description: Benzenedisulfonyl chloride is a corrosive organic compound. Ether and tertiary amyl alcohol are organic solvents. Iodine is

a corrosive, inorganic material. The following mixture was evaluated as a contaminant for lubricating oil: 100 gm benzenedisulfonyl chloride, 250 cc ether, 100 gm tertiary amyl alcohol, and 0.1 gm iodine. The volume proportions were 2.4% additive and 97.6% lubricating oil.

Comments: This mixture was tested. It was partially effective. Tests were conducted using a Plymouth engine running at $\frac{1}{4}$ load for $14\frac{1}{2}$ hours. The engine was noisy, ran roughly, and preignited. The rings were free, but one valve and one cam follower were tight.

Reference: Same as 43-1.

BENZENEDISULFONIC ACID—MESITYL OXIDE—OLEIC ACID 43-8

Description: Benzenedisulfonic acid is a crystalline organic acid used in organic synthesis. Mesityl oxide is a substituted butenone. Oleic acid is an unsaturated fatty acid. The following mixture was evaluated as a contaminant for lubricating oil: 50 gm benzenedisulfonic acid, 75 cc mesityl oxide and 50 cc oleic acid. The volume proportions were 1.5% additive and 98.5% lubricating oil.

Comments: The mixture was tested. It was partially effective. Tests were conducted using a Ford engine running at $\frac{1}{4}$, $\frac{1}{2}$, $\frac{3}{4}$, and full loads for 1 hour. The valves bound periodically during the test.

Reference: Same as 43-1.

BENZENEDISULFONIC ACID—ROSIN—ACETONE 43-9

Description: Benzenedisulfonic acid is a corrosive organic acid. Rosin is the hard part left over after distillation of turpentine. Acetone is an organic solvent. The following mixture was evaluated as a contaminant for lubricating oil: $33\frac{1}{3}$ gm benzenedisulfonic acid, $33\frac{1}{3}$ gm rosin, and 150 cc acetone. The weight proportions were 0.81% additive and 99.19% lubricating oil.

Comments: The mixture was tested. It was partially effective. Tests were conducted using a Plymouth engine running at $\frac{1}{4}$ and full loads for 1 hour. The engine was very tight immediately after shutting down. It broke loose after 2 hours of cooling but was very dirty. The oil pump screen was clogged and the oil pump could not be operated.

Reference: Same as 43-1.

p-TOLUENESULFONYL CHLORIDE—ETHER— FURFURYL ALCOHOL 43-10

Description: p-Toluenesulfonyl chloride is a noxious organic compound. Ether and furfuryl alcohol are organic solvents. The following mixture was evaluated as a contaminant for lubricating oil: 100 gm p-toluenesulfonyl chloride, 300 cc ether, and 100 cc furfuryl alcohol. The volume proportions were 6.1% additive and 93.9% lubricating oil.

Comments: This mixture was tested. It was partially effective. Tests were conducted using a Ford V-8 engine running at $\frac{1}{4}$ load for 1 hour. The oil pump screen was almost completely clogged by a coke-like material and some rings bound. The pan was covered with black lacquer. The babbitt bearings were not burned out, but were very loose. Twenty-four hours after the check run, the valves stuck in their guides. The gaskets were charred and had been leaking.

Reference: Same as 43-1.

PYROGALLOL—ETHER

43-11

Description: Pyrogallol is a strong organic oxidizing agent. Ether is an organic solvent. The following mixture was evaluated as a contaminant for lubricating oil: 100 gm pyrogallol and 175 cc of ethyl ether. The volume proportions were 3.7% additive and 96.3% lubricating oil.

Comments: This mixture was tested. It was partially effective. Tests were conducted using a Plymouth engine running at $\frac{1}{4}$ load for 1 hour. One valve and one cam follower were tight in their guides. The rod bearings had 0.004 inch play. The engine sounded as if it were pre-igniting and the torque fluctuated during the test.

Reference: Same as 43-1.

BENZENEDISULFONIC ACID

43-12

Description: Benzenedisulfonic acid is an acid used in organic synthesis. It was evaluated as a contaminant for lubricating oil. The weight proportions were 2.4% additive and 97.6% lubricating oil.

Comments: This material was tested. It was partially effective. Tests were conducted using a Ford engine running at $\frac{1}{4}$ load for 2 hours. The test engine froze immediately upon stopping but could be restarted after cooling.

Reference: Same as 43-1.

2-ISOVALERYL-1, 3-INDANDIONE—ETHER— MONODODECYL AMINE

43-13

Description: 2-isovaleryl-1, 3-indandione is an organic chemical. Ether is a flammable organic solvent. Monododecyl amine is a long chain amine. The following mixture was evaluated as a contaminant for lubricating oil: 60 gm 2-isovaleryl-1, 3-indandione, 450 cc ether, and 45 gm monododecyl amine. The volume proportions were 5.3% additive and 94.7% lubricating oil.

Comments: The mixture was tested. It was partially effective. Tests were conducted using a Ford engine running at $\frac{1}{4}$ and full loads for 2 hours. The main bearings were burned out. There was sludge in the

bottom of the pan and a floating semisolid material on the surface of the oil.

Reference: Same as 43-1.

BENZENEDISULFONIC ACID—ACETONE

43-14

Description: Benzenedisulfonic acid is an acid used in organic synthesis. Acetone is an organic solvent. The mixtures shown in the table were evaluated as contaminants for lubricating oil. There were some slight variations in treatment of the solution before testing.

No. tests	Benzenedisulfonic acid (gm)	Acetone (gm)	Weight (%) added to oil	Effect
2	100	150	2.4	Small quantities of rubbery deposit
2	50	75	1.2	No effect
3	400	600	2.6	No effect
2	200	300	5.3	No effect
1	100	150	2.4	Cam followers stuck
1	100	75	2.4	No effect
1	100	300	2.4	No effect
7	100	150	2.4	Partial effect
3	150	225	3.6	Followers stuck Power $\frac{1}{4}$ of normal
1	66	100	1.6	Power $\frac{1}{4}$ of normal

Comments: These mixtures were tested. They were partially effective. Tests were conducted using both Ford and Plymouth engines running at $\frac{1}{4}$ to full loads for 2 hours.

Reference: Same as 43-1.

p-TOLUENESULFONYL CHLORIDE—ETHER—CASTOR OIL

43-15

Description: p-toluenesulfonyl chloride is a noxious organic compound. Ether is a flammable organic solvent. Castor oil is obtained from castor bean seeds. The following mixture was evaluated as a contaminant for lubricating oil: 100 gm p-toluenesulfonyl chloride, 300 cc ether, and 100 gm castor oil. The volume proportions were 6.3% additive and 93.7% lubricating oil.

Comments: The mixture was tested. It was partially effective. Tests were conducted using a Plymouth engine running at $\frac{1}{4}$ and full loads for 1 hour. The engine was rough, backfired, and lost 20-25% of its power. One valve and one cam follower were snug in their guides. Both oil rings bound on four of the pistons.

Reference: Same as 43-1.

p-TOLUENESULFONIC ACID—ROSIN—ACETONE**43-16**

Description: p-toluenesulfonic acid is a colorless solid that is used as an organic intermediate. Rosin is the hard part left over after distillation of turpentine. Acetone is an organic solvent. The following mixture was evaluated as a contaminant for lubricating oil: 100 gm p-toluenesulfonic acid, 100 gm rosin, and 150 cc acetone. The weight proportions were 2.4% additive and 97.6% lubricating oil.

Comments: The mixture was tested. It was partially effective. Tests were conducted using a Plymouth engine running at $\frac{1}{4}$ and full loads for 1 hour. The engine was very tight. All engine parts were heavily coated and very dirty.

Reference: Same as 43-1.

**BENZENEDISULFONYL CHLORIDE—ETHER—
FURFURYL ALCOHOL****43-17**

Description: Benzenedisulfonyl chloride is a corrosive organic compound. Ether is a flammable organic solvent. Furfuryl alcohol is the alcohol derivative of furane. The mixture was evaluated as a contaminant for lubricating oil. The proportions are summarized below.

Test no.	Benzenedisulfonyl chloride (gm)	Ether (cc)	Furfuryl alcohol (gm)	Weight (%) added to oil
1	100	250	100	5.3
2	10	29	100	1.7

Comments: The mixture was tested. It was partially effective. Tests were conducted using Ford and Plymouth engines running at $\frac{1}{4}$ and full loads for 1 hour. One rod bearing was burned out and the oil pump was completely clogged. Oil penetrated the seal at the rear main bearing which leaked profusely. After removing the drain plug, about two inches of a mixture of sludge and oil remained in the oil pan in both tests.

Reference: Same as 43-1.

BENZENEDISULFONIC ACID—ETHER—CROTONALDEHYDE**43-18**

Description: Benzenedisulfonic acid is a crystalline organic acid used in organic synthesis. Ether is an organic solvent. Crotonaldehyde, also known as 2-butene-1-al, is a colorless liquid. The following mixture was evaluated as a contaminant for lubricating oil: 100 gm benzenedisulfonic acid, 150 cc ether, and 100 gm crotonaldehyde. The volume proportions were 3.1% additive and 96.9% lubricating oil.

Comments: The mixture was tested. It was partially effective. Two experiments were conducted. Tests were conducted using a Ford engine running at $\frac{1}{4}$ and full loads for 2 hours. The engine stopped after 11 min of full throttle operation in the first test because the valves stuck.

Reference: Same as 43-1.

BENZENEDISULFONIC ACID—ETHER—FURFURYL ALCOHOL 43-19

Description: Benzenedisulfonic acid is a corrosive organic acid. Ether is an organic solvent. Furfuryl alcohol is the alcohol derivative of furane. The following mixture was evaluated as a contaminant for lubricating oil: 100 gm benzenedisulfonic acid, 200 cc ether, and 100 gm furfuryl alcohol. The volume proportions were 4.2% additive and 95.8% lubricating oil.

Comments: The mixture was tested. It was partially effective. Tests were conducted using a Plymouth engine running at $\frac{1}{4}$ and full loads for $1\frac{1}{2}$ hours. All the rod bearings were burned out after one hour of full throttle operation. The oil cup was encased with a large piece of coke-like material.

Reference: Same as 43-1.

BENZENEDISULFONIC ACID—MESITYL OXIDE 43-20

Description: Benzenedisulfonic acid is a corrosive organic acid. Mesityl oxide is a substituted butenone. The mixture was evaluated as a contaminant for lubricating oil. Twenty seven experiments were conducted using various proportions of benzenedisulfonic acid and mesityl oxide. The proportions used are summarized in the table below.

<i>Test no.</i>	<i>Benzene-disulfonic acid (gm)</i>	<i>Mesityl oxide (cc)</i>	<i>Volume (%) added to oil</i>	<i>Effect</i>
1	150	225	4.5	Partially effective
2	100	50	3.0	Partially effective
3	50	75	1.5	No effect
4	50	75	1.5	Partially effective
5	66	100	2.0	Partially effective
6	25	40	0.8	Partially effective
7	25	40	0.8	Partially effective
8	50	75	1.6	No effect
9	25	40	0.9	No effect
10	25	40	0.9	No effect
11	50	75	1.1	Partially effective
12	50	75	1.6	Partially effective
13	75	113	2.4	Partially effective
14	50	75	1.5	No effect
15	100	150	3.0	No effect
16	25	75	1.5	No effect
17	100	150	3.0	Partially effective
18	50	75	1.5	Partially effective
19	50	75	1.5	Partially effective
20	50	75	1.5	Partially effective

<i>Test no.</i>	<i>Benzene-disulfonic acid (gm)</i>	<i>Mesityl oxide (cc)</i>	<i>Volume (%) added to oil</i>	<i>Effect</i>
21	100	150	3.0	No effect
22	100	150	3.0	Partially effective
23	100	150	3.0	No effect
24	100	150	3.0	Partially effective
25	100	150	3.0	Partially effective
26	100	150	3.0	Partially effective
27	75	75	1.5	Partially effective

Comments: The mixture was tested. It was partially effective. Tests were conducted using Ford and Plymouth engines running at $\frac{1}{4}$ to full loads for 2 hours.

Reference: Same as 43-1.

CHLOROSULFONIC ACID

43-21

Description: Chlorosulfonic acid is a corrosive liquid used in organic synthesis. It was evaluated as a contaminant for lubricating oil. The volume proportions were 2.1% additive and 97.9% lubricating oil.

Comments: This material was tested. It was partially effective. Tests were conducted using a Ford V-8 engine running at $\frac{1}{4}$ and full loads for 2 hours. Sticky, semisolid material formed in the oil pan and at scattered places in the engine interior almost immediately upon adding the acid to the oil. One oil ring bound but there was no effect on the engine performance.

Reference: Same as 43-1.

TUNG OIL

43-22

Description: Tung oil is a viscous oil used in paints. It was evaluated as a contaminant for lubricating oil. The volume proportions were 10% additive and 90% lubricating oil.

Comments: This material was tested. It was partially effective. Tests were conducted using a Ford Engine running at $\frac{1}{4}$ to full loads for 2 hours. Bearings failed and the rings bound. The engine was extremely dirty and there was much rubbery material that was difficult to remove.

Reference: Same as 43-1.

ETHYL SULFATE

43-23

Description: Ethyl sulfate, also called diethyl sulfate, is a colorless liquid. It was evaluated as a contaminant for lubricating oil. The volume proportions were 1.8% additive and 98.2% lubricating oil.

Comment: This material was tested. It was not effective. Tests were conducted using a Plymouth engine running at $\frac{1}{4}$ and full loads for 1 hour. The engine was noisy because a valve did not seat properly.

Reference: Same as 43-1.

ETHYL SULFATE—FURFURYL ALCOHOL

43-24

Description: Ethyl sulfate, also called diethyl sulfate, is a colorless liquid. Furfuryl alcohol is an organic solvent. The following mixture was evaluated as a contaminant for lubricating oil: 100 gm ethyl sulfate and 100 gm furfuryl alcohol. The volume proportions were 1.8% additive and 98.2% lubricating oil.

Comments: This mixture was tested. It was not effective. Tests were conducted using a Plymouth engine running at $\frac{1}{4}$ and full loads for 1 hour. Two pieces of coke-like material formed in the oil pan. The power dropped to about 50% at one time during the test.

Reference: Same as 43-1.

ETHYL CHLOROSULFONATE

43-25

Description: Ethyl chlorosulfonate is a viscous liquid which is the ethyl ester of chlorosulfonic acid. It was evaluated as a contaminant for lubricating oil. The weight proportions were 4.8% additive and 95.2% lubricating oil.

Comments: This material was tested. It was not effective. Tests were conducted using a Ford engine running at $\frac{1}{4}$ and full loads for 2 hours. There was some sludge in the oil pan.

Reference: Same as 43-1.

QUINOLINE

43-26

Description: Quinoline is a coal tar derivative used to make dyes and pigments. It was evaluated as a contaminant for lubricating oil. The volume proportions were 1.9% additive and 98.1% lubricating oil.

Comments: This material was tested. It was not effective. Tests were conducted using a Ford engine running at $\frac{1}{4}$ and full loads for 2 hours.

Reference: Same as 43-1.

CROTONALDEHYDE—IRON CARBONYL

43-27

Description: Crotonaldehyde, also known as 2-butene-1-al, is a colorless liquid. Iron carbonyl is a pale yellow liquid. The following mixture was evaluated as a contaminant for lubricating oil: 150 cc of crotonaldehyde and 30 cc of iron carbonyl. The volume proportions were 3.0% additive and 97.0% lubricating oil.

Comments: This mixture was tested. It was not effective. Tests were conducted using a Ford engine running at $\frac{1}{4}$ and full loads for $\frac{1}{4}$ hour. The rear main bearing burned out during the test. All parts of the engine were clean.

Reference: Same as 43-1.

TRIPHENYL PHOSPHITE

43-28

Description: Triphenyl phosphite, also called phenyl phosphite, is a liquid soluble in organic solvents. It was evaluated as a contaminant for lubricating oil. The weight proportions were 2.4% additive and 97.6% lubricating oil.

Comments: This material was tested. It was not effective. Tests were conducted using a Ford engine running at $\frac{1}{4}$ and full loads for 2 hours.

Reference: Same as 43-1.

FURFURYL ALCOHOL—CUPRIC CHLORIDE—ETHER

43-29

Description: Furfuryl alcohol is an organic solvent. Cupric chloride is a brownish-yellow powder soluble in water. Ether is an organic solvent. The following mixture was evaluated as a contaminant for lubricating oil: 100 gm furfuryl alcohol, 1 gm cupric chloride, and 200 cc ether. The weight proportions were 2.4% additive and 97.6% lubricating oil.

Comments: This mixture was tested. It was not effective. Tests were conducted using a Ford engine running at $\frac{1}{4}$ and full loads for 2 hours.

Reference: Same as 43-1.

CHLOROSULFONIC ACID—ACETONE

43-30

Description: Chlorosulfonic acid is a corrosive, colorless liquid used in organic synthesis. Acetone is an organic solvent. The following mixture was evaluated as a contaminant for lubricating oil: 84 cc of chlorosulfonic acid and 225 cc of acetone. The volume proportions were 4.5% additive and 95.5% lubricating oil.

Comments: This mixture was tested. It was not effective. Tests were conducted using a Plymouth engine running at $\frac{1}{4}$ and full loads for 1 hour.

Reference: Same as 43-1.

ETHYL SULFATE—p-TOLUENESULFONYL CHLORIDE—ETHER

43-31

Description: Ethyl sulfate, also called diethyl sulfate, is a colorless liquid. p-Toluenesulfonyl chloride is a noxious organic compound. Ether is an organic solvent. The following mixture was evaluated as a contaminant for lubricating oil: 100 gm ethyl sulfate, 100 gm p-toluenesulfonyl chloride and 300 cc of ether. The volume proportions were 1.8% additive and 98.2% lubricating oil.

Comments: This mixture was tested. It was not effective. Tests were conducted using a Ford engine running at $\frac{1}{4}$ and full loads for $1\frac{1}{4}$ hours.

Reference: Same as 43-1.

BENZENE SULFOCHLORIDE

43-32

Description: Benzene sulfochloride is a weakly corrosive organic acid. It was evaluated as a contaminant for lubricating oil. The volume proportions were 3.2% additive and 96.8% lubricating oil.

Comments: This material was tested. It was not effective. Tests were conducted using a Plymouth engine running at $\frac{1}{4}$ and full loads for 1 hour.

Reference: Same as 43-1.

FURFURYL ALCOHOL—IRON CARBONYL

43-33

Description: Furfuryl alcohol is an organic solvent. Iron carbonyl is a pale yellow liquid. The following mixture was evaluated as a contaminant for lubricating oil: 150 gm furfuryl alcohol and 30 cc iron carbonyl. The volume proportions were 3.6% additive and 96.4% lubricating oil.

Comments: This mixture was tested. It was not effective. Tests were conducted using a Plymouth engine running at $\frac{1}{4}$ and full loads for 1 hour.

Reference: Same as 43-1.

BENZENEDISULFONIC ACID—ISOPHORONE

43-34

Description: Benzenedisulfonic acid is an acid used in organic synthesis. Isophorone is a form of phorone, a member of the terpene group. The following mixture was evaluated as a contaminant for lubricating oil: 100 gm of benzenedisulfonic acid and 150 cc of isophorone. The volume proportions were 3.2% additive and 96.8% lubricating oil.

Comments: This mixture was tested. It was not effective. Tests were conducted using Ford and Plymouth engines running at $\frac{1}{4}$ and full loads for 1 hour. The oil cup screen and oil pan became quite dirty.

Reference: Same as 43-1.

PHOSPHORUS OXYCHLORIDE

43-35

Description: Phosphorus oxychloride is a colorless, fuming liquid. It was evaluated as a contaminant for lubricating oil. The volume proportions were 2.1% additive and 97.9% lubricating oil.

Comments: This material was tested. It was not effective. Tests were conducted using a Ford engine running at $\frac{1}{4}$ and full loads for 2 hours.

Reference: Same as 43-1.

MANGANESE NUODEX**43-36**

Description: Manganese nuodex is a manganese derivative of ammonium naphthenate. It was evaluated as a contaminant for lubricating oil. The volume proportions were 2% additive and 98% lubricating oil.

Comments: This material was tested. It was not effective. Tests were conducted using a Plymouth engine running at $\frac{1}{4}$ and full loads for 1 hour.

Reference: Same as 43-1.

CASTOR OIL—CONCENTRATED SULFURIC ACID**43-37**

Description: Castor oil is obtained from castor bean seeds. Concentrated sulfuric acid (98%) is a corrosive mineral acid. The following mixture was evaluated as a contaminant for lubricating oil: 150 gm castor oil and 30 gm concentrated sulfuric acid. The volume proportions were 0.3% additive and 99.7% lubricating oil.

Comments: The mixture was tested. It was not effective. Tests were conducted using a Ford engine running at $\frac{1}{4}$ and full loads for 2 hours.

Reference: Same as 43-1.

TUNG OIL—COBALT NUODEX**43-38**

Description: Tung oil is a rapidly drying oil which forms a film that is hard and waterproof and highly resistant to acids and alkalis. Cobalt nuodex is a cobalt derivative of ammonium naphthenate. The following mixture was evaluated as a contaminant for lubricating oil: 50 cc tung oil and 0.1% cobalt as cobalt nuodex. The volume proportions were 0.13% additive and 99.87% lubricating oil.

Comments: The mixture was tested. It was not effective. Tests were conducted using a Ford engine running at $\frac{1}{4}$ and full loads for $2\frac{1}{4}$ hours.

Reference: Same as 43-1.

BAKELITE CEMENT—BAKELITE HARDENER**43-39**

Description: Bakelite cement is an adhesive made of phenol-formaldehyde polymer. Bakelite hardener is a polymerization initiator. Bakelite, a phenolic resin, is the registered trade name of Union Carbide Corp. The mixture was evaluated as a contaminant for lubricating oil. The volume proportions were 2.2% additive and 97.8% lubricating oil.

Comments: This mixture was tested. It was not effective. Tests were conducted using a Ford engine running at $\frac{1}{4}$ and full loads for 2 hours.

Reference: Same as 43-1.

PHENOL—FURFURAL—CARBON TETRACHLORIDE**43-40**

Description: Phenol is a colorless, corrosive, organic base. Furfural is the aldehyde derivative of furane. Carbon tetrachloride is a colorless solvent. The following mixture was evaluated as a contaminant for lubricating oil: 130 gm phenol, 130 gm furfural, and 10 cc of carbon tetrachloride. The volume proportions were 5% additive and 95% lubricating oil.

Comments: This mixture was tested. It was not effective. Tests were conducted using Ford and Plymouth engines running at $\frac{1}{4}$ and full loads for 2 hours.

Reference: Same as 43-1.

CRESOL—FURFURYL ALCOHOL—CARBON TETRACHLORIDE**43-41**

Description: Cresol is a colorless solid. Furfuryl alcohol is an organic solvent. Carbon tetrachloride is a colorless solvent. The following mixture was evaluated as a contaminant for lubricating oil: 130 gm cresol, 130 gm furfuryl alcohol, and 10 cc of carbon tetrachloride. The volume proportions were 5% additive and 95% lubricating oil.

Comments: This mixture was tested. It was not effective. Tests were conducted using a Ford engine running at $\frac{1}{4}$ and full loads for 2 hours.

Reference: Same as 43-1.

BENZYL BROMIDE**43-42**

Description: Benzyl bromide, also known as α -bromo-toluene, is a colorless liquid. It was evaluated as a contaminant for lubricating oil. The volume proportions were 3.9% additive and 96.1% lubricating oil.

Comments: This material was tested. It was not effective. Tests were conducted using a Plymouth engine running at $\frac{1}{4}$ and full loads for 1 hour.

Reference: Same as 43-1.

ROSIN—ETHYL ETHER**43-43**

Description: Rosin is the resinous part of the oleo-resin exuded by various species of pine, known in commerce as crude turpentine. Ethyl ether is an organic solvent. The following mixture was evaluated as a contaminant for lubricating oil: 100 gm rosin and 150 cc of ethyl ether. The weight proportions were 2.4% additive and 97.6% lubricating oil.

Comments: This mixture was tested. It was not effective. Tests were conducted using a Plymouth engine running at $\frac{1}{4}$ and full loads for 1 hour.

Reference: Same as 43-1.

ETHYL ABIETATE—COBALTOUS ACETATE**43-44**

Description: Ethyl abietate is a liquid derived from abietic acid. Cobaltous acetate is the salt formed by reaction of cobalt and acetic acid. The mixture was evaluated as a contaminant for lubricating oil. The volume proportions were 4.3% additive and 95.7% lubricating oil.

Comments: This mixture was tested. It was not effective. Tests were conducted using a Ford V-8 engine running at $\frac{1}{4}$ and full loads for 2 hours.

Reference: Same as 43-1.

ISO-AMYL NITRATE**43-45**

Description: Iso-amyl nitrate is a colorless liquid insoluble in organic solvents. It was evaluated as a contaminant for lubricating oil. The weight proportions were 2.4% additive and 97.6% lubricating oil.

Comments: This material was tested. It was not effective. Tests were conducted using a Ford engine running at $\frac{1}{4}$ and full loads for 2 hours. A small amount of tar-like material formed in the oil pan.

Reference: Same as 43-1.

TAR—CARBON DISULFIDE**43-46**

Description: Tar is the mixture of constituents remaining from the distillation of petroleum. Carbon disulfide is a flammable liquid used in organic synthesis. This mixture was evaluated as a contaminant for lubricating oil. The volume proportions were 3.0% additive and 97.0% lubricating oil.

Comments: The mixture was tested. It was not effective. Tests were conducted using a Ford engine running at $\frac{1}{4}$ and full loads for 2 hours.

Reference: Same as 43-1.

TRICRESYL PHOSPHATE**43-47**

Description: Tricresyl phosphate, also called tritoyl phosphate, is a liquid soluble in organic solvents. It was evaluated as a contaminant for lubricating oil. The volume proportions were 4.2% additive and 95.8% lubricating oil.

Comments: This material was tested. It was not effective. Tests were conducted using a Plymouth engine running at $\frac{1}{4}$ and full loads for 1 hour.

Reference: Same as 43-1.

IRON NUODEX**43-48**

Description: Iron nuodex is an iron derivative of ammonium naphthenate. It was evaluated as a contaminant for lubricating oil. The volume proportions were 0.03% additive and 99.97% lubricating oil.

Comments: This material was tested. It was not effective. Tests were conducted using a Plymouth engine running at $\frac{1}{4}$ and full loads for 16 hours. Both rod bearings and main bearings lost 0.09 gm weight.

Reference: Same as 43-1.

FURFURYL ALCOHOL—COPPER OLEATE—ETHER 43-49

Description: Furfuryl alcohol is an organic solvent. Copper oleate is the copper salt of oleic acid, an unsaturated fatty acid. Ether is a flammable organic solvent. The following mixture was evaluated as a contaminant for lubricating oil: 100 gm furfuryl alcohol, 6 gm copper oleate, and 200 cc ether. The volume proportions were 4.0% and 96.0% lubricating oil.

Comments: This mixture was tested. It was not effective. Tests were conducted using a Ford engine running at $\frac{1}{4}$ and full loads for 2 hours.

Reference: Same as 43-1.

COPPER NUODEX 43-50

Description: Copper nuodex is a copper derivative of ammonium naphthenate. It was evaluated as a contaminant for lubricating oil. The weight proportions were 0.5% additive and 99.5% lubricating oil.

Comments: The material was tested. It was not effective. Tests were conducted using a Plymouth engine running at $\frac{1}{4}$ and full loads for 15½ hours. There were weight reductions in rod bearings of 0.08 gm and in main bearings of 0.124 gm.

Reference: Same as 43-1.

p-TOLUENESULFONYL CHLORIDE—ACETONE 43-51

Description: p-toluenesulfonyl chloride is a noxious organic compound. Acetone is an organic solvent. The following mixture was evaluated as a contaminant for lubricating oil: 111 gm p-toluenesulfonyl chloride and 200 cc acetone. The volume proportions were 4.2% additive and 95.8% lubricating oil.

Comments: The mixture was tested. It was not effective. Tests were conducted using a Plymouth engine running at $\frac{1}{4}$ and full loads for 1 hour. Some sludge formed in the oil pan.

Reference: Same as 43-1.

WHITE PHOSPHORUS—CARBON DISULFIDE 43-52

Description: White phosphorus is a waxy material that is insoluble in water. Carbon disulfide is a flammable liquid used in organic synthesis. The following mixture was evaluated as a contaminant for lubricating oil: 20 gm white phosphorus and 50 cc of carbon disulfide. The weight proportions were 0.14% additive and 99.86% lubricating oil.

Comments: The mixture was tested. It was not effective. Tests were conducted using a Ford engine running at $\frac{1}{4}$ and full loads for $1\frac{1}{4}$ hours. There was severe knocking, but no other effect on the engine operation or condition.

Reference: Same as 43-1.

BENZENEDISULFONIC ACID—ACETONE—CASTOR OIL 43-53

Description: Benzenedisulfonic acid is a crystalline acid used in organic synthesis. Acetone is an organic solvent. Castor oil is obtained from castor bean seeds. The following mixture was evaluated as a contaminant for lubricating oil: 100 gm benzenedisulfonic acid, 100 cc acetone, and 50 cc castor oil. The volume proportions were 2.0% additive and 98.0% lubricating oil.

Comments: The mixture was tested. It was not effective. Tests were conducted using a Ford engine running at $\frac{1}{4}$ and full loads for 2 hours.

Reference: Same as 43-1

ZINC OLEATE 43-54

Description: Zinc oleate is the zinc salt of oleic acid which is an unsaturated acid. It was evaluated as a contaminant for lubricating oil. The weight proportions were 1% additive and 99% lubricating oil.

Comments: This material was tested. It was not effective. Tests were conducted using 1933 Chevrolet engine running at $\frac{1}{3}$ and full loads for 3 hours.

Reference: Same as 43-1.

PHENYLACETALDEHYDE—ALCOHOL—BENZOYL PEROXIDE 43-55

Description: Phenylacetaldehyde, also called α -toluylaldehyde, is a colorless liquid. Alcohol, also called ethanol is an organic solvent. Benzoyl peroxide is a strong organic oxidizing agent used as a polymerization initiator. The following mixture was evaluated as a contaminant for lubricating oil: 100 gm phenylacetaldehyde, 100 gm alcohol and 3 gm benzoyl peroxide. The volume proportions were 2.2% additive and 97.8% lubricating oil.

Comments: The mixture was tested. It was not effective. Tests were conducted using a Ford engine running at $\frac{1}{4}$ and full loads for 2 hours.

Reference: Same as 43-1.

p-TOLUENESULFONIC ACID—MESITYL OXIDE 43-56

Description: p-toluenesulfonic acid is a colorless solid that is used as an organic intermediate. Mesityl oxide is a substituted butenone. The following mixture was evaluated as a contaminant for lubricating oil:

100 gm p-toluenesulfonic acid and 150 cc mesityl oxide. The volume proportions were 3.0% additive and 97.0% lubricating oil.

Comments: The material was tested. It was not effective. Tests were conducted using a Plymouth engine running at $\frac{1}{4}$ and full loads for 1 hour.

Reference: Same as 43-1.

p-TOLUENESULFONIC ACID—ACETONE—TUNG OIL **43-57**

Description: p-toluenesulfonic acid is a colorless solid that is used as an organic intermediate. Acetone is an organic solvent. Tung oil is a rapidly drying oil which forms a film that is hard, waterproof, and highly resistant to acids and alkalies. The following mixture was evaluated as a contaminant for lubricating oil: 100 gm p-toluenesulfonic acid, 100 cc acetone, and 200 gm tung oil. The weight proportions were 2.4% additive and 97.6% lubricating oil.

Comments: The mixture was tested. It was not effective. Tests were conducted using a Plymouth engine running at $\frac{1}{4}$ and full loads for 1 hour.

Reference: Same as 43-1.

FURFURYL ALCOHOL **43-58**

Description: Furfuryl alcohol is an organic solvent. It was evaluated as a contaminant for lubricating oil. The volume proportions were 24 $\frac{1}{2}$ % additive and 75 $\frac{1}{2}$ % lubricating oil as well as 10% additive and 90% lubricating oil.

Comments: This material was tested. It was not effective. Tests were conducted using a Briggs & Stratton test engine under an idle load for 2 hours.

Reference: Same as 43-1.

SALICYLIC ACID **43-59**

Description: Salicylic acid is an organic acid used as an intermediate in organic synthesis. It was evaluated as a contaminant for lubricating oil. The volume proportions were 5% additive and 95% lubricating oil.

Comments: This material was tested. It was not effective. Tests were conducted using a Ford engine running at $\frac{1}{4}$ load for 2 hours.

Reference: Same as 43-1.

ALUMINUM CHLORIDE—ABSOLUTE ETHER **43-60**

Description: Aluminum chloride is a strongly corrosive metal salt. Absolute ether is an organic solvent. The following mixture was evaluated as a contaminant for lubricating oil: 50 gm aluminum chloride and 50

gm absolute ether. The weight proportions were 1.2% additive and 98.8% lubricating oil.

Comments: This mixture was tested. It was not effective. Tests were conducted using a Ford engine running at $\frac{1}{4}$ load for 2 hours.

Reference: Same as 43-1.

VINYL ACETATE—BENZOYL PEROXIDE 43-61

Description: Vinyl acetate is a monomer. Benzoyl peroxide is a polymerization catalyst. The following mixture was evaluated as a contaminant for lubricating oil: 473 cc vinyl acetate and 5 gm benzoyl peroxide. The volume proportions were 10% additive and 90% lubricating oil.

Comments: This solution was tested. It was not effective. Tests were conducted using a Plymouth engine running at $\frac{1}{4}$ load for one hour.

Reference: Same as 43-1.

**TUNG OIL—BENZENE—COBALT NUODEX—
BENZOYL PEROXIDE 43-62**

Description: Tung oil is a fast-drying oil which forms a film that is hard and waterproof and highly resistant to acids and alkalis. Benzene is an organic solvent. Cobalt nuodex is the cobalt derivative of ammonium naphthenate. Benzoyl peroxide is a polymerization catalyst. The following mixture was evaluated as a contaminant for lubricating oil: 900 cc tung oil, 25 cc benzene, 25 cc cobalt nuodex and 10 gm benzoyl peroxide. The volume proportions were 10% additive and 90% lubricating oil.

Comments: This solution was tested. It was not effective. Tests were conducted using a Plymouth engine running at $\frac{1}{4}$ load for 2 hours.

Reference: Same as 43-1.

BENZENEDISULFONIC ACID—DIACETONE ALCOHOL 43-63

Description: Benzenedisulfonic acid is a corrosive organic acid. Diacetone alcohol, also called diacetone, is a colorless liquid. The following mixture was evaluated as a contaminant for lubricating oil: 100 gm benzenedisulfonic acid and 100 cc diacetone alcohol. The volume proportions were 2.4% additive and 97.6% lubricating oil.

Comments: The mixture was tested. It was not effective. Tests were conducted using a Plymouth engine running at $\frac{1}{4}$ and full loads for 1 hour. A jelly-like sludge formed in the oil pump but the engine was free and there was very little deposit on the bearings or pistons.

Reference: Same as 43-1.

p-TOLUENESULFONYL CHLORIDE—ETHER**43-64**

Description: p-toluenesulfonyl chloride is a noxious organic compound. Ether is a flammable organic solvent. The following mixture was evaluated as a contaminant for lubricating oil: 110 gm p-toluenesulfonyl chloride and 300 cc of ether. The volume proportions were 6.4% additive and 93.6% lubricating oil.

Comments: The mixture was tested. It was not effective. Tests were conducted using a Plymouth engine running at $\frac{1}{4}$ and full loads for 1 hour. Some sludge formed in the oil pan.

Reference: Same as 43-1.

BENZENEDISULFONIC ACID—ETHER**43-65**

Description: Benzenedisulfonic acid is a corrosive organic acid. Ether is an organic solvent. The following mixture was evaluated as a contaminant for lubricating oil: 100 gm benzenedisulfonic acid and 200 cc ether. The volume proportions were 4.2% additive and 95.8% lubricating oil.

Comments: The mixture was tested. It was not effective. Tests were conducted using a Plymouth engine running at $\frac{1}{4}$ and full loads for 1 hour. Some sludge formed in the oil pump and on top of the oil cup; the rest of the engine was clean.

Reference: Same as 43-1.

BENZENEDISULFONYL CHLORIDE—ETHER—FURFURAL**43-66**

Description: Benzenedisulfonyl chloride is a corrosive organic compound. Ether is a low flammable organic solvent. Furfural is the aldehyde derivative of furane. The following mixture was evaluated as a contaminant for lubricating oil: 100 gm benzenedisulfonyl chloride, 250 cc ether, and 100 gm furfural. The volume proportions were 5.3% additive and 94.7% lubricating oil.

Comments: The mixture was tested. It was not effective. Tests were conducted using a Ford engine running at $\frac{1}{4}$ and full loads for 2 hours. Hard flakes of coke-like material formed in the subpan, but the rest of the engine was clean.

Reference: Same as 43-1.

BENZENEDISULFONIC ACID—ETHER—ACETONE**43-67**

Description: Benzenedisulfonic acid is a corrosive organic acid. Ether and acetone are organic solvents. The following mixture was evaluated as a contaminant for lubricating oil: 100 gm benzenedisulfonic acid, 200 cc, ether and 150 cc acetone. The volume proportions were 4.2% additive and 95.8% lubricating oil.

Comments: The mixture was tested. It was not effective. Tests were conducted using a Plymouth engine running at $\frac{1}{4}$ and full loads for 1 hour. Some stick material formed in the oil pan.

Reference: Same as 43-1.

**p-TOLUENESULFONYL CHLORIDE—ETHER—
TERTIARY AMYL ALCOHOL**

43-68

Description: p-Toluenesulfonyl chloride is a noxious organic compound. Ether and tert-amyl alcohol are organic solvents. The following mixture was evaluated as a contaminant for lubricating oil: 100 gm p-toluenesulfonyl chloride, 300 cc ether, and 100 gm tert-amyl alcohol. The volume proportions were 6.3% additive and 93.7% lubricating oil.

Comments: The mixture was tested. It was not effective. Tests were conducted using a Ford engine running at $\frac{1}{4}$ and full loads for 2 hours.

Reference: Same as 43-1.

FURFURYL ALDEHYDE

43-69

Description: Furfuryl aldehyde is an easily oxidizable organic aldehyde derived from furane. It was evaluated as a contaminant for lubricating oil. The volume proportions were 10% additive and 90% lubricating oil.

Comments: This material was tested. It was not effective. Tests were conducted using a Ford engine running at $\frac{1}{4}$ and full loads for 2 hours.

Reference: Same as 43-1.

RICINOLEIC ACID—SULFUR

43-70

Description: Ricinoleic acid is an unsaturated fatty acid. Sulfur is a nonmetallic element, usually in the form of a yellow powder. The mixture was evaluated as a contaminant for lubricating oil. The weight proportions were 4% ricinoleic acid, 1% sulfur and 95% lubricating oil.

Comments: This mixture was tested. It was not effective. Tests were conducted using a Plymouth engine running at $\frac{1}{4}$ and full loads for 1 hour.

Reference: Same as 43-1.

SILICON TETRACHLORIDE

43-71

Description: Silicon tetrachloride is a colorless, fuming liquid. It was evaluated as a contaminant for lubricating oil. The weight proportions were 2.5% additive and 97.5% lubricating oil.

Comments: This material was tested. It was not effective. Tests were conducted using a Plymouth engine running at $\frac{1}{4}$ and full loads for 1 hour.

Reference: Same as 43-1.

BENZENEDISULFONIC ACID—ETHER—ALDOL**43-72**

Description: Benzenedisulfonic acid is a corrosive organic acid. Ether is an organic solvent. Aldol is a colorless liquid soluble both in water and organic solvents. The following mixture was evaluated as a contaminant for lubricating oil: 100 gm benzenedisulfonic acid, 150 ether, and 100 cc aldol. The volume proportions were 2.1% additive and 97.9% lubricating oil.

Comments: The mixture was tested. It was not effective. Tests were conducted using a Ford engine running at $\frac{1}{4}$ and full loads for 2 hours.

Reference: Same as 43-1.

CONCENTRATED SULFURIC ACID—ACETONE**43-73**

Description: Concentrated sulfuric acid (98%) is corrosive mineral acid. Acetone is an organic solvent. The mixture was evaluated as a contaminant for lubricating oil. The proportions of additive are summarized below.

<i>Test no.</i>	<i>Conc. sulfuric acid (cc)</i>	<i>Acetone (cc)</i>	<i>Volume (%) added to oil</i>
1	23	150	3.0
2	35	225	4.5

Comments: The mixture was tested. It was not effective. Tests were conducted using Ford and Plymouth engines running at $\frac{1}{4}$ and full loads for 2 hours. In the second test the engine turned freely but could not be started because valves stuck.

Reference: Same as 43-1.

STYRENE—BENZOYL PEROXIDE**43-74**

Description: Styrene is a highly reactive monomer used in polymerizations. Benzoyl peroxide is a strong oxidizing agent used to initiate polymerizations. The following mixture was evaluated as a contaminant for lubricating oil: 473 cc of styrene and 5 gm of benzoyl peroxide. The volume proportions were 10% additive and 90% lubricating oil.

Comments: This mixture was tested. It was not effective. Tests were conducted using a Plymouth engine running at $\frac{1}{4}$ load for 1 hour.

Reference: Same as 43-1.

YELLOW PHOSPHORUS**43-75**

Description: Yellow phosphorus is a slightly impure form of white phosphorus, a waxy material that is insoluble in water. It was evaluated as a contaminant for lubricating oil. The volume proportions were 0.8% additive and 99.2% lubricating oil.

Comments: This material was tested. It was not effective. Tests were conducted using a Plymouth engine running at $\frac{1}{4}$ load for 1 hour. The additive caused preignition but no harmful effect.

Reference: Same as 43-1.

BENZENEDISULFONIC ACID—ACETONE— β —NAPHTHOL 43-76

Description: Benzenedisulfonic acid is a corrosive organic acid. Acetone is an organic solvent. β -naphthol is a crystalline intermediate used in organic syntheses. The following mixture was evaluated as a contaminant for lubricating oil: 50 gm benzenedisulfonic acid, 75 cc acetone, and 25 gm β -naphthol. The volume proportions were 1.5% additive and 98.5% lubricating oil.

Comments: The mixture was tested. It was not effective. Tests were conducted using a Plymouth engine running at $\frac{1}{4}$ and full loads for 1 hour.

Reference: Same as 43-1.

BENZENEDISULFONIC ACID—ACETONE—IODINE 43-77

Description: Benzenedisulfonic acid is a corrosive organic acid. Acetone is an organic solvent. Iodine is a bluish-black, crystalline solid. The following mixture was evaluated as a contaminant for lubricating oil: 100 gm benzenedisulfonic acid, 150 cc acetone, and 2 gm of iodine. The volume proportions were 3.0% additive and 97.0% lubricating oil.

Comments: The mixture was tested. It was not effective. Tests were conducted using a Plymouth engine running at $\frac{1}{4}$ and full loads for 1 hour.

Reference: Same as 43-1.

BENZENEDISULFONYL CHLORIDE—2-METHYL-2,4-PENTANEDIOL—ETHER 43-78

Description: Benzenedisulfonyl chloride is a corrosive organic compound. 2-Methyl-2,4-pentanediol is a colorless liquid soluble in organic solvents. Ether is an organic solvent. The following mixture was evaluated as a contaminant for lubricating oil: 100 gm benzenedisulfonyl chloride, 100 cc of 2-methyl-2,4-pentanediol chloride, 100 cc of 2-methyl-2,4-pentanediol, and 200 cc ether. The volume proportions were 2.0% additive and 98.0% lubricating oil.

Comment: The mixture was tested. It was not effective. Tests were conducted using a Plymouth engine running at $\frac{1}{4}$ and full loads for 2 hours.

Reference: Same as 43-1.

BENZENEDISULFONYL CHLORIDE—ALLYL ALCOHOL—ETHER 43-79

Description: Benzenedisulfonyl chloride is a corrosive organic compound. Allyl alcohol is a colorless liquid soluble in organic solvents. The following mixture was evaluated as a contaminant for lubricating oil: 100 gm benzenedisulfonyl chloride, 100 cc allyl alcohol and 200 cc ether. The volume proportions were 2.0% additive and 98.0% lubricating oil.

Comments: The mixture was tested. It was not effective. Tests were conducted using a Plymouth engine running at $\frac{1}{4}$ and full loads for 1 hour.

Reference: Same as 43-1.

**DICYCLOPENTADIENE—COBALT NUODEX—
BENZOYL PEROXIDE 43-80**

Description: Dicyclopentadiene is a fraction that consists of polymerized cyclopentadiene. Cobalt nuodex is the cobalt derivative of ammonium naphthenate. Benzoyl peroxide is a polymerization initiator. The following mixture was evaluated as a contaminant for lubricating oil: 460 cc of dicyclopentadiene, 13 cc of cobalt nuodex, and 5 gm of benzoyl peroxide. The volume proportions were 10% additive and 90% lubricating oil.

Comments: This mixture was tested. It was not effective. Tests were conducted using a 1932 Ford V-8 engine running at $\frac{1}{3}$ and full loads for 2 hours.

Reference: Same as 43-1.

LINSEED OIL—COBALT NUODEX—BENZOYL PEROXIDE 43-81

Description: Linseed oil is a viscous oil obtained from flax seeds. Cobalt nuodex is the cobalt derivative of ammonium naphthenate. Benzoyl peroxide is a polymerization initiator. The following mixture was evaluated as a contaminant for lubricating oil: 400 cc linseed oil, 13 cc cobalt nuodex, and 5 gm benzoyl peroxide. The volume proportions were 10% additive and 90% lubricating oil.

Comments: This mixture was tested. It was not effective. Tests were conducted using a 1938 Plymouth engine running at $\frac{1}{3}$ and full loads for 1 hour.

Reference: Same as 43-1.

INDENE 43-82

Description: Indene is an unsaturated organic chemical used for polymerizations. It was evaluated as a contaminant for lubricating oil. The volume proportions were 3% additive and 97% lubricating oil.

Comments: The material was tested. It was not effective. Tests were conducted using a special laboratory test engine.

Reference: NRL Report P-1954, Sabotage Agents for Use in Lubricants and Fuel for Internal Combustion Engines, H. R. Baker and C. M. Murphy, Naval Research Laboratory, Oct 30, 1942.

VINYL ACETATE

43-83

Description: Vinyl acetate is an unsaturated organic chemical used for polymerizations. Two tests were conducted, using vinyl acetate alone and with an inhibitor. The materials were evaluated as contaminants for lubricating oil. The volume proportions were 3% additive and 97% lubricating oil.

Comments: The material was tested. It was not effective. Tests were conducted using a special laboratory test engine.

Reference: Same as 43-82.

ETHYL ACETOACETATE

43-84

Description: Ethyl acetoacetate is a liquid used in organic syntheses. It was evaluated as a contaminant for lubricating oil. The volume proportions were 3% additive and 97% lubricating oil.

Comments: The material was tested. It was not effective. Tests were conducted using a special laboratory test engine.

Reference: Same as 43-82.

HEXALDEHYDE

43-85

Description: Hexaldehyde, also known as hexanal, is a colorless liquid used in organic syntheses. It was evaluated as a contaminant for lubricating oil. The volume proportions were 3% additive and 97% lubricating oil.

Comments: The material was tested. It was not effective. Tests were conducted using a special laboratory test engine.

Reference: Same as 43-82.

PENTALYN G—BENZENE—KELLIN

43-86

Description: Pentalyn G is a plastic produce of Hercules Powder Co., Inc. Benzene is an organic solvent. Kellin, a product of Spencer Kellogg and Sons, Inc, is a chemically treated varnish oil having linseed and soybean oils as bases. The mixture was evaluated as a contaminant for lubricating oil. The volume proportions were 3% additive and 97% lubricating oil.

Comments: The mixture was tested. It was not effective. Tests were conducted using a special laboratory test engine. The engine was very dirty after the test but there was no effect on the operation of the test engine.

Reference: Same as 43-82.

ROSIN—BENZENE

43-87

Description: Rosin is a naturally occurring product obtained from various species of pine. Benzene is an organic solvent. The mixture was evaluated as a contaminant for lubricating oil. The volume proportions were 3% additive and 97% lubricating oil.

Comments: The mixture was tested. It was not effective. Tests were conducted using a special laboratory test engine. The engine was very dirty after the test, but there was no effect on the operation of the test engine.

Reference: Same as 43-82.

ROSIN—BENZENE—KELLIN

43-88

Description: Rosin is a naturally occurring product obtained from various species of pine. Benzene is an organic solvent. Kellin, a product of Spencer Kellog and Sons, Inc., is a chemically treated varnish oil having linseed and soybean oils as bases. The mixture was evaluated as a contaminant for lubricating oil. The volume proportions were 3% additive and 97% lubricating oil.

Comments: The mixture was tested. It was not effective. Tests were conducted using a special laboratory test engine. The engine was very dirty, but there was no effect on the operation of the test engine.

Reference: Same as 43-82.

NYPENE

43-89

Description: Nypene is a terpene resin product of The Newville Company. It was evaluated as a contaminant for lubricating oil. The volume proportions were 3% additive and 97% lubricating oil.

Comments: The material was tested. It was not effective. Tests were conducted using a special laboratory test engine. The engine was very dirty after the test, but there was no effect on the operation of the test engine.

Reference: Same as 43-82.

SUPERBECKACITE 1001—BENZENE

43-90

Description: Super Beckacite 1001 is a phenolic resin, a product of Reichhold Chemicals, Inc. Benzene is an organic solvent. The mixture

was evaluated as a contaminant for lubricating oil. The volume proportions were 3% additive and 97% lubricating oil.

Comments: The mixture was tested. It was not effective. Tests were conducted using a special laboratory test engine. The engine was very dirty after the test, but there was no effect on the operation of the test engine.

Reference: Same as 43-82.

ELECTRICAL INSULATING VARNISH

43-91

Description: Electrical Insulating Varnish is an oil soluble varnish produced by Wm. Zinsser & Co. Two different varnishes, Type G and R were evaluated as contaminants for lubricating oil. The volume proportions were 3% additive and 97% lubricating oil.

Comments: The materials were tested. They were not effective. Tests were conducted using a special laboratory test engine. The engine was very dirty after the test, but there was no effect on the operation of the test engine.

Reference: Same as 43-82.

ETHYLORTHOSILICATE

43-92

Description: Ethylorthosilicate is an alkylated liquid chemical. It was evaluated as a contaminant for lubricating oil. The volume proportions were 3% additive and 97% lubricating oil.

Comments: The material was tested. It was not effective. Tests were conducted using a special laboratory test engine. The ethylorthosilicate decomposed to form an abrasive material, but the particles were so fine that they only had a polishing action on the bearings and cylinder walls.

Reference: Same as 43-82.

TRIAMYL BORATE

43-93

Description: Triamyl borate is the alkyl ester of boric acid. It was evaluated as a contaminant for lubricating oil. The volume proportions were 3% additive and 97% lubricating oil.

Comments: The material was tested. It was not effective. Tests were conducted using a special laboratory test engine. There was no noticeable effect on the operation of the test engine.

Reference: Same as 43-82.

ROSIN OIL

43-94

Rosin oil is a naturally occurring organic chemical obtained from various species of pine. It was evaluated as a contaminant for lubricating oil. The volume proportions were 3% additive and 97% lubricating oil.

Comments: The material was tested. It was not effective. Tests were conducted using a special laboratory test engine. There was no noticeable effect on the operation of the test engine.

Reference: Same as 43-82.

PINE OIL

43-95

Description: Pine oil is a naturally occurring organic chemical obtained from various species of pine. It was evaluated as a contaminant for lubricating oil. The volume proportions were 3% additive and 97% lubricating oil.

Comments: The material was tested. It was not effective. Tests were conducted using a special laboratory test engine. There was no noticeable effect on the operation of the test engine.

Reference: Same as 43-82.

PINE TAR OIL

43-96

Description: Pine tar oil is a naturally occurring organic chemical obtained from various species of pine. It was evaluated as a contaminant for lubricating oil. The volume proportions were 3% additive and 97% lubricating oil.

Comments: The material was tested. It was not effective. Tests were conducted using a special laboratory test engine. There was no noticeable effect on the operation of the test engine.

Reference: Same as 43-82.

PINENE

43-97

Description: Pinene is an unsaturated colorless liquid used in organic syntheses and polymerizations. It was evaluated as a contaminant for lubricating oil. The volume proportions were 3% additive and 97% lubricating oil.

Comments: The material was tested. It was not effective. Tests were conducted using a special laboratory test engine. There was some sticking of the rings with accompanying high oil consumption and the formation of some sludge but no noticeable effect on the operation of the test engine.

Reference: Same as 43-82.

HEXONE

43-98

Description: Hexone, also known as iso-butyl ketone, is a colorless liquid used in organic syntheses. It was evaluated as a contaminant for lubricating oil. The volume proportions were 3% additive and 97% lubricating oil.

Comments: The material was tested. It was not effective. Tests were conducted using a special laboratory test engine. There was some sticking of the rings with accompanying high oil consumption and the formation of some sludge but no noticeable effect on the operation of the test engine.

Reference: Same as 43-82.

TRIETHYL AMINE

43-99

Description: Triethyl amine is a colorless oil used in organic syntheses. It was evaluated as a contaminant for lubricating oil. The volume proportions were 3% additive and 97% lubricating oil.

Comments: The material was tested. It was not effective. Tests were conducted using a special laboratory test engine. There was some sticking of the rings with accompanying high oil consumption and the formation of some sludge but no noticeable effect on the operation of the test engine.

Reference: Same as 43-82.

MANGANESE LINOLEATE

43-100

Description: Manganese linoleate is the manganese derivative of linoleic acid, an unsaturated light-yellow oil used for polymerizations. It was evaluated as a contaminant for lubricating oil. The volume proportions were 3% additive and 97% lubricating oil.

Comments: The material was tested. It was not effective. Tests were conducted using a special laboratory test engine. There was some sticking of the rings with accompanying high oil consumption and the formation of some sludge but no noticeable effect on the operation of the test engine.

Reference: Same as 43-82.

BUNKER-C FUEL OIL

43-101

Description: Bunker-C fuel oil is a fraction obtained from the distillation of petroleum. It was evaluated as a contaminant for lubricating oil. The volume proportions were 3% additive and 97% lubricating oil.

Comments: The material was tested. It was not effective. Tests were conducted using a special laboratory test engine. There was some sticking of the rings with accompanying high oil consumption and the formation of some sludge but no noticeable effect on the operation of the test engine.

Reference: Same as 43-82.

α -METHYL STYRENE**43-102**

Description: α -Methyl styrene is an alkylated derivative of styrene, an unsaturated organic chemical used for polymerizations. It was evaluated as a contaminant for lubricating oil. The volume proportions were 3% additive and 97% lubricating oil.

Comments: The material was tested. It was not effective. Tests were conducted using a special laboratory test engine.

Reference: Same as 43-82.

YELLOW PHOSPHORUS—CARBON DISULFIDE**43-103**

Description: Yellow phosphorus is a slightly impure form of white phosphorus, a waxy material that is insoluble in water. Carbon disulfide is a highly flammable liquid used in organic synthesis. The following mixture was evaluated as a fuel contaminant: 1 gm of yellow phosphorus per cc of carbon disulfide. The concentrations were 2.0, 4.0, and 9.25 cc per gallon of fuel.

Comments: This mixture was tested. It was not effective. Tests were conducted using a Ford engine running at $\frac{1}{4}$ and full loads for $1\frac{1}{2}$ hours. There was severe knocking, but no preignition and no permanent effect on engine operation or condition.

Reference: Sabotaging Engines by Additions to the Lubricating Oil, T. A. Boyd, Ethyl Corporation, Final Report, Mar 11, 1943, Contract 283, OEMar-428.

BROWN SUGAR**43-104**

Description: Brown sugar is the less refined type of the ordinary household sugar. It was evaluated as a fuel contaminant. The weight used was 100 gm additive in 12 gal. of fuel.

Comments: This material was tested. It was not effective. Tests were conducted using a Ford engine running at $\frac{1}{4}$ and full loads for 2 hours. The engine stopped once because of an undissolved sample obstructing the fuel line.

Reference: Sabotaging Engines by Additions to the Lubricating Oil, T. A. Boyd, Ethyl Corporation, Final Report, Mar 11, 1943, Contract 283, OEMar-428.

Section 44. OTHER CONTAMINANTS**n-BUTYLDICHLOROPHOSPHINE****44-1**

Description: n-Butyldichlorophosphine is a chemical used in organic synthesis. A concentration of 44 parts per million in air was evaluated as a proknock for leaded base 100-octane aviation gasoline.

Comments: This material was tested. It was effective. The test was made in a standard CFR knock test engine using the American Society for Testing and Materials method (ASTM-D 357-40). The concentration used reduced the antiknock value by 12 octane units but did not damage the engine. The tests indicated that it is impractical to attempt destruction of an automotive engine by lowering the octane rating.

Reference: Sabotage of Gasoline Engines, T. K. Sherwood and F. C. Wilcox, NDRC, Div. 11, Office of Scientific Research and Development, Vol. 2, Chapt. 14, 1946 (ATI-12 066).

ARSENIC TRICHLORIDE

44-2

Description: Arsenic trichloride, also called butter of arsenic, is an oily liquid. A concentration of 49 parts per million in air was evaluated as a proknock for leaded base 100-octane aviation gasoline.

Comments: This material was tested. It was effective. The test was made in a standard CFR knock test engine using the American Society for Testing and Materials method (ASTM-D 357-40). The concentration used reduced the antiknock value by 12 octane units but did not damage the engine. The tests indicated that it is impractical to attempt destruction of an automotive engine by lowering the octane rating.

Reference: Same as 44-1.

ARSENIOUS ACID ANHYDRIDE

44-3

Description: Arsenious acid anhydride is a chemical used in inorganic synthesis. A concentration of 50 parts per million in air was evaluated as a proknock for leaded base 100-octane aviation gasoline.

Comments: This material was tested. It was effective. The test was made in a standard CFR knock test engine using the American Society for Testing and Materials method (ASTM-D 357-40). The concentration used reduced the antiknock value by 12 octane units but did not damage the engine. The tests indicated that it is impractical to attempt destruction of an automotive engine by lowering the octane rating.

Reference: Same as 44-1.

SULFUR TRIOXIDE

44-4

Description: Sulfur trioxide is a colorless solid soluble in sulfuric acid. A concentration of 60 parts per million in air was evaluated as a proknock for leaded base 100-octane aviation gasoline.

Comments: This material was tested. It was effective. The test was made in a standard CFR knock test engine using the American Society for Testing and Materials methods (ASTM-D 357-40). The concentration used reduced the antiknock value by 12 octane units but did not

damage the engine. The tests indicated that it is impractical to attempt destruction of an automotive engine by lowering the octane rating.

Reference: Same as 44-1.

SULFUR DICHLORIDE

44-5

Description: Sulfur dichloride is a dark red fuming liquid used in organic synthesis. A concentration of 62 parts per million in air was evaluated as a proknock for leaded base 100-octane aviation gasoline.

Comments: This material was tested. It was effective. The test was made in a standard CFR knock test engine using the American Society for Testing and Materials method (ASTM-D 357-40). The concentration used reduced the antiknock value of the fuel by 12 octane units but did not damage the engine. The tests indicated that it is impractical to attempt destruction of an automotive engine by lowering the octane rating.

Reference: Same as 44-1.

SULFUR MONOCHLORIDE

44-6

Description: Sulfur monochloride is a red-yellow liquid used in organic synthesis. A concentration of 68 parts per million in air was evaluated as a proknock for leaded base 100-octane aviation gasoline.

Comments: This material was tested. It was effective. The test was made in a standard CFR knock test engine using the American Society for Testing and Materials method (ASTM-D 357-40). The concentration used reduced the antiknock value by 12 octane units but did not damage the engine. The tests indicated that it is impractical to attempt destruction of an automotive engine by lowering the octane rating.

Reference: Same as 44-1.

DICHLORONITROETHANE

44-7

Description: 1,1-Dichloro-1-nitroethane is a chemical used in organic synthesis. A concentration of 72 parts per million in air was evaluated as a proknock for leaded base 100-octane aviation gasoline.

Comments: This material was tested. It was effective. The test was made in a standard CFR knock test engine using the American Society for Testing and Materials method (ASTM-D 357-40). The concentration used reduced the antiknock value of the fuel by 12 octane units but did not damage the engine. The tests indicated that it is impractical to attempt destruction of an automotive engine by lowering the octane rating.

Reference: Same as 44-1.

CHLORONITROPROPANE**44-8**

Description: 1-Chloro-1-nitropropane is a chemical used in organic synthesis. A concentration of 80 parts per million in air was evaluated as a proknock for leaded base 100-octane aviation gasoline.

Comments: This material was tested. It was effective. The test was made in a standard CFR knock test engine using the American Society for Testing and Materials method (ASTM-D 357-40). The concentration used reduced the antiknock value of the fuel by 12 octane units but did not damage the engine. The tests indicated that it is impractical to attempt destruction of an automotive engine by lowering the octane rating.

Reference: Same as 44-1.

PHOSPHORUS SULFOCHLORIDE**44-9**

Description: Phosphorus sulfochloride is an organic chemical used in synthesis. A concentration of 85 parts per million in air was evaluated as a proknock for leaded base 100-octane aviation gasoline.

Comments: This material was tested. It was effective. The test was made in a standard CFR knock test engine using the American Society for Testing and Materials method (ASTM-D 357-40). The concentration used reduced the antiknock value of the fuel by 12 octane units but did not damage the engine. The tests indicated that it is impractical to attempt destruction of an automotive engine by lowering the octane rating.

Reference: Same as 44-1.

PHOSPHORUS TRICHLORIDE**44-10**

Description: Phosphorus trichloride is a colorless, fuming liquid soluble in organic solvents. A concentration of 87 parts per million in air was evaluated as a proknock for leaded base 100-octane aviation gasoline.

Comments: This material was tested. It was effective. The test was made in a standard CFR knock test engine using the American Society for Testing and Materials method (ASTM-D 357-40). The concentration used reduced the antiknock value of the fuel by 12 octane units but did not damage the engine. The tests indicated that it is impractical to attempt destruction of an automotive engine by lowering the octane rating.

Reference: Same as 44-1.

ETHYL THIONITRITE**44-11**

Description: Ethyl thionitrite is a chemical used in organic synthesis. A concentration of 88 parts per million in air was evaluated as a proknock for leaded base 100-octane aviation gasoline.

Comments: This material was tested. It was effective. The test was made in a standard CFR knock test engine using the American Society for Testing and Materials method (ASTM-D 357-40). The concentration used reduced the antiknock value of the fuel by 12 octane units but did not damage the engine. The tests indicated that it is impractical to attempt destruction of an automotive engine by lowering the octane rating.

Reference: Same as 44-1.

SULFUR TRIOXIDE—CHLOROSULFONIC ACID

44-12

Description: Sulfur trioxide is a colorless solid. Chlorosulfonic acid is a colorless liquid used in organic synthesis. The following concentration was evaluated as a proknock for gasoline: 90 parts by weight of a mixture of 55% sulfur trioxide and 45% chlorosulfonic acid per million parts of air. The fuel used was leaded base 100-octane aviation gasoline.

Comments: This material was tested. It was effective. The test was made in a standard CFR knock test engine using the American Society for Testing and Materials method (ASTM-D 357-40). The concentration used reduced the antiknock value of the fuel by 12 octane units but did not damage the engine. The tests indicated that it is impractical to attempt destruction of an automotive engine by lowering the octane rating.

Reference: Same as 44-1.

NITROSYL CHLORIDE

44-13

Description: Nitrosyl chloride is a yellow-brown gas. A concentration of 95 parts per million in air was evaluated as a proknock for leaded base 100-octane aviation gasoline.

Comments: This material was tested. It was effective. The test was made in a standard CFR knock test engine using the American Society for Testing and Materials method (ASTM-D 357-40). The concentration used reduced the antiknock value of the fuel by 12 octane units but did not damage the engine. The tests indicated that it is impractical to attempt destruction of an automotive engine by lowering the octane rating.

Reference: Same as 44-1.

ETHYLHEXYL NITRITE—CHLOROPICRIN

44-14

Description: 2-Ethylhexyl nitrite and chloropicrin, also called nitrochloroform, are chemicals used in organic synthesis. The following concentration was evaluated as a proknock for gasoline: 270 parts per million in air of equal parts of 2-ethylhexyl nitrite and chloropicrin. The fuel used was nonleaded base 100-octane aviation gasoline.

Comments: This material was tested. It was effective. The test was made in a standard CFR knock test engine using the American Society for Testing and Materials method (ASTM-D 357-40). The concentration used reduced the antiknock value of the fuel by 12 octane units but did not damage the engine. The tests indicated that it is impractical to attempt destruction of an automotive engine by lowering the octane rating.

Reference: Same as 44-1.

ETHYLHEXYL NITRITE

44-15

Description: 2-Ethylhexyl nitrite is a chemical used in organic synthesis. A concentration of 290 parts per million in air was evaluated as a proknock for nonleaded base 100-octane aviation gasoline.

Comments: This material was tested. It was effective. The test was made in a standard CFR knock test engine using the American Society for Testing and Materials method (ASTM-D 357-40). The concentration used reduced the antiknock value of the fuel by 12 octane units but did not damage the engine. The tests indicated that it is impractical to attempt destruction of an automotive engine by lowering the octane rating.

Reference: Same as 44-1.

CHLOROPICRIN—ISOAMYL NITRITE

44-16

Description: Chloropicrin, also called nitrochloroform, and isoamyl nitrite are organic chemicals used in synthesis. The following concentration was evaluated as a proknock for gasoline: 317 parts by weight of equal parts of chloropicrin and isoamyl nitrite per million parts of air. The fuel used was non-leaded base 100-octane aviation gasoline.

Comments: This material was tested. It was effective. The test was made in a standard CFR knock test engine using the American Society for Testing and Materials method (ASTM-D 357-40). The concentration used reduced the antiknock value of the fuel by 12 octane units but did not damage the engine. The tests indicated that it is impractical to attempt destruction of an automotive engine by lowering the octane rating.

Reference: Same as 44-1.

CHLOROETHYL NITRITE

44-17

Description: 2-Chloroethyl nitrite is a chemical used in organic synthesis. A concentration of 290 parts per million in air was evaluated as a proknock for nonleaded base 100-octane aviation gasoline.

Comments: This material was tested. It was effective. The test was made in a standard CFR knock test engine using the American Society for Testing and Materials method (ASTM-D 357-40). The concentra-

tion used reduced the antiknock value of the fuel by 12 octane units but did not damage the engine. The tests indicated that it is impractical to attempt destruction of an automotive engine by lowering the octane rating.

Reference: Same as 44-1.

IOSAMYL NITRITE

44-18

Description: Isoamyl nitrite is a colorless liquid used in organic synthesis. A concentration of 500 parts per million in air was evaluated as a proknock for nonleaded base 100-octane aviation gasoline.

Comments: This material was tested. It was effective. The test was made in a standard CFR knock test engine using the American Society for Testing and Materials method (ASTM-D 357-40). The concentration used reduced the antiknock value of the fuel by 12 octane units but did not damage the engine. The tests indicated that it is impractical to attempt destruction of an automotive engine by lowering the octane rating.

Reference: Same as 44-1.

CHLOROFORM—ISOAMYL NITRITE

44-19

Description: Chloroform and isoamyl nitrite are chemicals used in organic synthesis. The following concentration was evaluated as a proknock for gasoline: 550 parts by weight of equal parts of chloroform and isoamyl nitrite per million parts of air. The fuel was nonleaded base 100-octane aviation gasoline.

Comments: This material was tested. It was effective. The test was made in a standard CFR knock test engine using the American Society for Testing and Materials method (ASTM-D 357-40). The concentration used reduced the antiknock value of the fuel by 12 octane units but did not damage the engine. The tests indicated that it is impractical to attempt destruction of an automotive engine by lowering the octane rating.

Reference: Same as 44-1.

ISOAMYL NITRITE—n-BUTYL SULFIDE

44-20

Description: Isoamyl nitrite and n-butyl sulfide are chemicals used in organic synthesis. The following concentration was evaluated as a proknock for gasoline: 550 parts by weight of equal parts of isoamyl nitrite and n-butyl sulfide per million parts of air. The fuel used was nonleaded base 100-octane aviation gasoline.

Comments: This material was tested. It was effective. The test was made in a standard CFR knock test engine using the American Society for Testing and Materials method (ASTM-D 357-40). The concentra-

tion used reduced the antiknock value of the fuel by 12 octane units but did not damage the engine. The tests indicated that it is impractical to attempt destruction of an automotive engine by lowering the octane rating.

Reference: Same as 44-1.

AMYL NITRATE

44-21

Description: Amyl nitrate is a colorless liquid used in organic synthesis. A concentration of 620 parts per million in air was evaluated as a proknock for nonleaded base 100-octane aviation gasoline.

Comments: This material was tested. It was effective. The test was made in a standard CFR knock test engine using the American Society for Testing and Materials method (ASTM-D 357-40). The concentration used reduced the antiknock value of the fuel by 12 octane units but did not damage the engine. The tests indicated that it is impractical to attempt destruction of an automotive engine by lowering the octane rating.

Reference: Same as 44-1.

CHLOROPICRIN—ISOAMYL NITRITE—n-BUTYL SULFIDE

44-22

Description: Chloropicrin, isoamyl nitrite, and n-butyl sulfide are chemicals used in organic synthesis. The following concentration was evaluated as a proknock for gasoline: 620 parts by weight of equal parts of chloropicrin, isoamyl nitrite and n-butyl sulfide per million parts of air. The fuel used was non-leaded base 100-octane aviation gasoline.

Comments: This material was tested. It was effective. The test was made in a standard CFR knock test engine using the American Society for Testing and Materials method (ASTM-D 357-40). The concentration used reduced the antiknock value of the fuel by 12 octane units but did not damage the engine. The tests indicated that it is impractical to attempt destruction of an automotive engine by lowering the octane rating.

Reference: Same as 44-1.

ISOAMYL NITRATE—n-BUTYL SULFIDE

44-23

Description: Isoamyl nitrate and n-butyl sulfide are chemicals used in organic synthesis. The following concentration was evaluated as a proknock for gasoline: 680 parts by weight of equal parts of isoamyl nitrate and n-butyl sulfide per million parts of air. The fuel used was nonleaded base 100-octane aviation gasoline.

Comments: This material was tested. It was effective. The test was made in a standard CFR knock test engine using the American Society

for Testing and Materials method (ASTM-D 357-40). The concentration used reduced the antiknock value of the fuel by 12 octane units but did not damage the engine. The tests indicated that it is impractical to attempt destruction of an automotive engine by lowering the octane rating.

Reference: Same as 44-1.

ISOAMYL NITRATE

44-24

Description: Isoamyl nitrate is a colorless liquid used in organic synthesis. A concentration of 700 parts per million in air was evaluated as a proknock for nonleaded base 100-octane aviation gasoline.

Comments: This material was tested. It was effective. The test was made in a standard CFR knock test engine using the American Society for Testing and Materials method (ASTM-D 357-40). The concentration used reduced the antiknock value of the fuel by 12 octane units but did not damage the engine. The tests indicated that it is impractical to attempt destruction of an automotive engine by lowering the octane rating.

Reference: Same as 44-1.

n-BUTYL SULFIDE—CHLOROPICRIN

44-25

Description: n-Butyl sulfide and chloropicrin are chemicals used in organic synthesis. The following concentration was evaluated as a proknock for gasoline: 720 parts by weight of equal parts of n-butyl sulfide and chloropicrin per million parts of air. The fuel was nonleaded base 100-octane aviation gasoline.

Comments: This material was tested. It was effective. The test was made in a standard CRF knock test engine using the American Society for Testing and Materials method (ASTM-D 357-40). The concentration used reduced the antiknock value of the fuel by octane units but did not damage the engine. The tests indicated that it is impractical to attempt destruction of an automotive engine by lowering the octane rating.

Reference: Same as 44-1.

TERTIARY BUTYL THIONITRITE

44-26

Description: Tertiary butyl thionitrite is a chemical used in organic synthesis. A concentration of 750 parts per million in air was evaluated as a proknock for nonleaded base 100-octane aviation gasoline.

Comments: This material was tested. It was effective. The test was made in a standard CFR knock test engine using the American Society for Testing and Materials method (ASTM-D 357-40). The concentration used reduced the antiknock value of the fuel by 12 octane units but

did not damage the engine. The tests indicated that it is impractical to attempt destruction of an automotive engine by lowering the octane rating.

Reference: Same as 44-1.

PHENOLIC RESIN

44-27

Description: Phenolic resins are prepared by polymerizing phenol with various unsaturated compounds. It was evaluated as a proknock for fuel. The concentration was one-half gallon of a fuel containing 10 gm of phenolic resin.

Comments: This material was tested. It was effective. A rapid evaluation of this material was obtained using a one-cylinder air-cooled Delco-motor-generator. The material was then tested with a multi-cylinder motor and finally checked by road testing using a 1½-ton Ford truck. The intake valve of the cylinder bound. The motor could not be restarted without overhauling.

Reference: Report OSRD-81, Chemical Treatment of Oils (Sabotage of Gasoline), NDRC Div. 11 (Monsanto Chemical Co.), Office of Scientific Research and Development, Mar 7, 1941.

CHINAWOOD OIL

44-28

Description: Chinawood oil is a viscous oil used in the manufacture of varnish. It was evaluated as a proknock for fuel. The concentration was one gallon of fuel containing 20 gm chinawood oil.

Comments: This material was tested. It was effective. A rapid evaluation of the material was obtained using a one-cylinder air-cooled Delco motor-generator. The material was then tested with a multi-cylinder motor and finally checked by road testing using a 1½ ton Ford truck. Carbon formed sufficiently to bind piston rings after 1 to 2 gallons of gasoline per cylinder had been consumed.

Reference: Same as 44-27.

ROSIN ESTER

44-29

Description: Rosin ester is a resin constituent obtained from various species of pine. It was evaluated as a proknock for fuel. The concentration was one-half of a fuel containing 10 gm of rosin ester.

Comments: This material was tested. It was effective. A rapid evaluation of the material was obtained using a one-cylinder air-cooled Delco motor-generator. The material was then tested with a multicylinder motor and finally checked by road testing using a 1½ ton Ford truck. The intake valve of the cylinder bound. The motor could not be restarted without overheating.

Reference: Same as 44-27.

WHITE PHOSPHORUS

44-30

Description: White phosphorus is a waxy solid, very soluble in carbon disulfide, and usually stored under water. It was evaluated as a proknock for fuel. In the first reference, the concentration used was 6.4 parts per million parts of air in lead-treated fuel. In the second reference, the concentration used was 6.4 parts by weight of white phosphorus per million parts in air.

Comments: This material was tested. The material was effective. In the first reference, it was shown that it was not possible to reduce the octane number of nonleaded fuel by 12 octane units. In the second reference, the concentration used reduced the antiknock value by 12 octane units. White phosphorus cannot be used by dispensing it through the air because it would immediately oxidize and lose effectiveness; nor can it be added directly to the fuel because the dry material may ignite on exposure to air. The tests indicated that it is impractical to attempt destruction of an automotive engine by lowering the octane rating.

References: Report OSRD-1281, Supplement To "Proknock," (Ethyl Corporation), NDRC, Div. 11, Office of Scientific Research and Development, Mar 20, 1943.

Sabotage of Gasoline Engines, T. K. Sherwood and F. C. Wilcox, NDRC, Div. 11, Office of Scientific Research and Development, Vol. 2, Chapt. 14, 1946 (ATI-12 066).

NITROGEN CHLORIDE

44-31

Description: Nitrogen chloride is a liquid with a specific gravity of 1.65 that explodes at 210° F. It was evaluated as a proknock for fuel. In the first reference, the concentration used was 29 parts per million parts of air in lead treated fuel. In the second reference, the concentration used was 29 parts by weight of nitrogen chloride per million parts of air.

Comments: This material was tested. The material was effective. In the first reference, the concentration used produced a reduction of 6.5 octane units. In the second reference, the concentration used reduced the antiknock value by 12 octane units. The material explodes on contact with organic materials, especially turpentine. It is soluble in chloroform, CCl_4 , CS_2 , PCl_3 , and benzene. The tests indicated that it is impractical to attempt destruction of an automotive engine by lowering the octane rating.

References: Report OSRD-1281, Supplement To "Proknock," (Ethyl Corporation), NDRC, Div. 11, Office of Scientific Research and Development, Mar 20, 1943.

Sabotage of Gasoline Engines, T. K. Sherwood and F. C. Wilcox, NDRC, Div. 11, Office of Scientific Research and Development, Vol. 2, Chapt. 14, 1946 (ATI-12 066).

INDEX

Abstract	Page
Abrasive materials (<i>See also</i> specific material)	42-1 to 42-4 184 to 185
Acetic acid, glacial	43-3 186
Acetone	43-5, 43-6, 43-0, 43-14, 43-16 43-30, 43-51, 43-53, 43-57, 43-67 43-73, 43-76, 43-77 187, 188, 190, 191, 195, 200, 201, 202, 204, 206, 207
Acid delay	03-2 24
Air strip mine	28-5 132
Alarm clock delay (<i>See also</i> Clock delay)	03-14 30
Alcohol	02-10, 02-11, 43-55 14, 201
Aldol	43-72 206
Algerian FLN devices (<i>See</i> specific device.)	
All-ways switch	26-1 94
Allyl alcohol	43-79 208
Altimeter switch	26-2 94
Aluminum chloride	43 60 202
Aluminum powder	01-2, 01-13 4, 8
Amatol	14-8 43
Ammonal	14-18 46
Ammonium nitrate	14-13, 22-8 44
Ammunition, small arms	33-1, 33-2 180, 181
Amyl:	
Alcohol, tertiary	43-7, 43-68 187, 205
Borate	43-93 211
Nitrate	43-45, 44-21, 44-23, 44-24 190, 221, 222
Phosphoric acid	41-1 182
Animal blood	02-13 15
Antilift mine	28-1 120
Antipersonnel firing device	25-5 79
Antipersonnel mines	28-1, 28-14, 28-15, 27-17, 28-22, 28-25 to 28-28 129, 138, 139, 141, 145, 147 to 149
Antivehicle mines	28-9, 28-10, 28-12, 28-17 to 28-20 134, 135, 136, 141 to 144
Arsenic trichloride	44-2 215
Arsenious acid anhydride	44-3 215
Assassination firearm	32-15, 32-18 178, 179
Bakelite	43-39 197
Balancing stick delay	03-12 29
Ballistics, small arms	33-1 180
Bangalore torpedos	22-2, 22-4, 27-20 51, 52, 124
Barium peroxide	01-9 7
Barney Google	27-4 111

	<i>Abstract</i>	<i>Page</i>
Beckacite	43-90	210
Benzene	43-62, 43-86 to 43-88, 43-90	203, 209 to 210
Benzenedisulfonic acid	43-1, 43-4, 43-6, 43-8, 43-9, 43-12, 43-14, 43-18 to 43-20, 43-34, 43-53, 43-63, 43-65, 43-67, 43-72, 43-76, 43-77	185, 187, 188, 189, 190, 191 to 192, 196, 201, 203, 204, 206, 207
Benzenedisulfonyl chloride	43-7, 43-17, 43-66, 43-78, 43-79	187, 191, 204, 207, 208
Benzene sulfochloride	43-32	196
Benzoyl peroxide	43-55, 43-61, 43-62, 43-74, 43-80, 43-81	201, 203, 206, 208
Benzyl bromide	43-42	198
Bicycle boobytrap	27-24	127
Black powder	12-1	39
Blasting:		
Caps	11-4, 11-5	36, 37
Gelatin	14-10	44
Machine	26-11	100
Blood	02-13	15
Bomb, time	29-3	157
Boobytraps (<i>See also specific</i>		
device, Mines)	27-1 to 27-25	108 to 128
Firing device (<i>See also</i>		
Firing device)	01-14	9
Fuse (<i>See also Fuses</i>)	24-9	73
Book boobytrap	27-1, 27-7, 27-8	108, 114, 115
Bottle boobytrap	27-9	116
Bottle, incendiary	02-25	22
Brick, incendiary	02-14, 02-17	15, 17
British devices (<i>See specific</i>		
device.)		
Bromobenzene	41-7	184
Bunker-C fuel oil	43-101	213
Butane sulfonyl chloride	41-6	183
Butyldichlorophosphine	44-1	214
Butyl sulfide	44-20, 44-22, 44-23, 44-25	220, 221, 222
Butyl thionitrite, tertiary	44-26	222
Caltrops	27-21, 27-22	125
Can boobytrap	27-17, 27-25	121, 128
Candle delay	02-8	27
Candy bar boobytrap	27-15	120
Canteen boobytrap	27-13	118
Capsule, incendiary	02-22	20
Carbon disulfide	43-46, 43-52, 43-103	199, 200, 214
Carbon tetrachloride	43-40, 43-41	198
Castor oil	43-1, 43-15, 43-37, 43-53	185, 190, 197, 201
Chemical delay fuse	24-10, 24-13	74, 76
Chemical materials (<i>See</i>		
specific material.)		
Chinawood oil	44-28	223

	<i>Abstract</i>	<i>Page</i>
Chloroethyl nitrite	44-17	219
Chloroform	44-19	220
Chloronitropropane	44-8	217
Chloropicrin	44-14, 44-16, 44-22, 44-25	218, 219, 221, 222
Chlorosulfonic acid	43-21, 43-30, 44-12	193, 195, 218
Cigar, incendiary	02-19	18
Cigarette delays	03-1, 03-3	23, 25
Cigarette lighter firearm	32-15	178
Clock delays	03-14, 25-3	30, 78
Clock switches	26-12 to 26-15, 26-17, 26-18	101 to 103, 104, 105
Clogging materials (<i>See also</i> specific material.)	43-1 to 43-104	185 to 214
Clothespin switches	26-4, 26-5	96
Coal, explosive	14-21, 14-22	46, 47
Cobalt drier	04-1 to 04-4	30 to 33
Cobalt nuodex	43-38, 43-62, 43-80, 43-81	197, 203, 208
Cobaltous acetate	43-44	199
Combustible materials	04-1 to 04-4	30 to 33
Composition B	14-11	44
Composition C4	14-12	44
Concussion detonator	11-2	34
Copper:		
Chloride	43-29	195
Naphenate	42-4	185
Nuodex	43-50	200
Oleate	43-49	200
Corrosive materials (<i>See also</i> specific material.)	41-1 to 41-5	182 to 184
Cratering charges	22-8, 22-11	54, 56
Cresol	43-31	195
Cresyl phosphate	43-47	199
Crotonaldehyde	43-18, 43-27	191, 194
Cylinder, incendiary	02-24	21
DDNP	13-4	41
Delay:		
Blasting cap	11-5	37
Bomb	29-3	157
Firing devices	25-3, 25-4, 25-7	78, 81
Fuses	24-5, 24-8, 24-10, 24-11, 24-13	70, 72, 74, 76
Incendiary	02-6	13
<i>Mechanisms (See also</i> Firing devices, Clocks, specific item)	03-1 to 03-14	23 to 30
Switches	26-6, 26-7, 26-9	97, 98, 99
Demolition:		
Blocks	22-5 to 22-7, 22-9, 22-10, 22-21, 22-22	52 to 53, 54, 55, 64, 65
Charges (<i>See also</i> specific charge)	22-1 to 22-22	64, 65

<i>Abstract</i>	<i>Page</i>
Techniques (<i>See also</i> specific technique)21-1, 21-2	50
Detonating cord24-1	67
Detonator, mechanical11-2	34
Detonators, electric11-3, 11-9	35, 38
Diacetone alcohol43-63	203
Dichlorobenzene41-5	183
Dichloronitroethane44-7	184
Dichloronitropropane41-2	182
Dicyclopentadiene43-80	208
Door knob switch26-21	107
Dynamite14-6, 14-7	42, 43
Egg thickener02-12	15
Electric initiators11-1, 11-3 to 11-6, 11-9	34, 35 to 37, 38
Ether43-1, 43-4, 43-7, 43-10 to 43-19, 43-29, 43-31, 43-43, 43-49, 43-60, 43-64 to 43-68, 43-72, 43-78, 43-79	185, 187, 188 to 192, 195, 198, 200, 202, 204 to 205, 206, 207, 208
Ethyl:	
Abietate43-44	199
Acetoacetate43-84	209
Alcohol43-55	201
Amine43-99	213
Chlorosulfonate43-25	194
Ether43-43	198
Hexyl nitrite44-14, 44-15	218, 219
Orthosilicate43-92	211
Sulfate43-23, 43-24, 43-31	193, 194, 195
Thionitrite44-11	217
Explosive:	
Applications (<i>See specific</i> device.)	
Coal14-21, 14-22	46, 47
Cutting21-1, 21-2	50
Materials (<i>See specific</i> material.)	
Ordnance (<i>See specific</i> item.)	
Safety15-1	48
Fire bottles02-5, 02-6, 02-16	12, 13, 16
Fire fudge01-4	5
Firing devices (<i>See also</i> specific device)25-1 to 25-21	76 to 93
Firing switches (<i>See also</i> specific item)26-1 to 26-21	94 to 107
Flammable liquids02-4	12
Flammability of gases16-1	48
Flashlight boobytrap27-11	117
Foreign devices (<i>See specific</i> device.)	

<i>Abstract</i>	<i>Page</i>
Fougasse	28-13 137
Fountain pen (<i>See</i> Pen.)	
Fragmentation mines	28-22, 28-25 to 28-28 145, 147 to 149
French ammonal	12-2 39
Fuel:	
Contaminants	43-103, 43-104, 44-1 to 44-31 214, 214 to 224
Gelled	02-3, 02-7 to 02-13 11, 13, 15
Oil, bunker	43-101 213
Proknocks	44-1 to 44-31 214 to 224
Furfural	43-40, 43-66 198, 204
Furfuryl alcohol	43-10, 43-17, 43-19, 43-24, 43-29, 43-33, 43-41, 43-49, 43-58 188, 191, 192, 194, 195, 196, 198, 200, 202
Furfuryl aldehyde	43-69 205
Fuse:	
Cord	23-1, 23-2 66
Delay igniter	03-1 23
Igniter	01-6, 01-14, 01-17, 25-1, 25-2 6, 9, 10, 76, 77
Fuses (<i>See also</i> specific item)	24-1 to 24-13 67 to 76
Gas flammability	10-1 48
Gasoline, gelled	02-3 11
Gelatin capsule delay	03-4 25
Gelled fuels	02-3, 02-7 to 02-13 11, 13 to 15
German devices (<i>See</i> specific device.)	
Glycerin	01-12 8
Glyceroldichlorohydrin	41-8 184
Grenade:	
Antitank	20-0 to 20-12 163 to 165
Boobytrap	27-23 126
Hand	29-1, 29-2, 29-5 to 29-12 156, 159 to 165
Incendiary	02-23, 02-26 21, 23
Mine	28-4, 28-9, 28-10 131, 134, 135
Shaped charge	29-9, 29-10 163
Gun cotton	14-17 45
Hand grenade (<i>See</i> Grenade.)	
Harmful additives (<i>See</i> specific material.)	
Headset boobytrap	27-5 112
Hexaldehyde	43-85 209
Hexone	43-88 212
High explosives (<i>See</i> Primary high explosives, Secondary high explosives, specific material.)	
HMX	14-14 45
Igniters (<i>See also</i> specific item)	01-1 to 01-17 4 to 10
Improvised devices:	
Boobytraps (<i>See also</i> specific device)	27-1 to 27-25 108 to 128

<i>Abstract</i>	<i>Page</i>
Delay mechanisms for	
incendiaries03-1 to 03-14	23 to 30
Delay switches26-6, 26-7, 26-9, 26-12	97, 98, 99, 101
Electric initiators11-1, 11-9	34, 38
Explosive, plastic14-19	46
Fire bottles, incendiary ...02-5, 02-6, 02-16	12, 13, 16
Firing switches26-1 to 26-10, 26-12, 26-16, 26-19, 26-21	94 to 100, 101, 104, 106, 107
Fuse23-2	66
Fuse, pull release24-7	71
Grenades29-1, 29-2	156
Igniter, no-flash01-17	10
Initiators, electric11-1, 11-9	34, 38
Incendiary delays03-1 to 03-14	23 to 30
Mines (<i>See also specific</i> device)28-1 to 28-10, 28-12, 28-13, 28-15, 28-16	129 to 135, 136, 137, 139, 140
Pistol32-1	168
Shaped charge22-1	51
Shotgun32-2	169
Switches26-1 to 26-10, 26-12, 26-16, 26-19, 26-21	94 to 100, 101, 104, 106, 107
Watch delay26-12	101
Incendiary:	
Delays (<i>See also specific</i> mechanism)03-1 to 03-14	23 to 30
Devices (<i>See also specific</i> device)02-14 to 02-26	15 to 23
Materials (<i>See also</i> specific material)02-1 to 02-15	11 to 16
Indene43-82	208
Initiators (<i>See also specific</i> item)11-1 to 11-9	34, 38
Iodine43-7, 43-77	187, 207
Iron:	
Carbonyl43-27, 43-33	194, 196
Napthenate42-2	185
Nuodex43-48	199
Isophorone43-34	196
Isovaleryl-indandione43-13	189
Japanese devices (<i>See specific</i> device.)	
Kellin43-86, 43-88	209, 210
Latex02-7	13
Lead:	
Aside13-4	41
Drier04-1 to 04-4	30 to 33
Napthenate42-3	185
Styphnate13-2	40

<i>Abstract</i>	<i>Page</i>	
Limpets	22-18, 28-11	62, 136
Linseed oil	04-1, 43-81	30, 208
Low explosives (<i>See also</i> specific material)	12-1, 12-2	39
Lubricant contaminants	43-1 to 43-102	185 to 214
Lye	02-9, 02-10	14
Machinegun	32-3	169
Magnesium powder	01-7, 01-9	6, 7
Manganese linoleate	43-100	213
Manganese nuodex	43-36	197
Match igniter	01-5, 01-6, 01-11	5, 6, 7
Mercury fulminate	13-1	40
Mesityl oxide	43-8, 43-20, 43-56	188, 192, 201
Methyl-pentanediol	43-78	207
Methyl styrene	43-102	214
Mines (<i>See also</i> specific device)	28-1 to 28-36	129 to 155
Monodecyl amine	43-13	189
Mortar shell mnic	28-21, 28-35	144, 155
Napalm	02-1	11
Naphthol	43-76	207
Nitramon cratering charge	27-11	117
Nitrobenzene	41-4	183
Nitrogen chloride	44-31	224
Nitroglycerin	14-5	42
Nitrostarch	14-2	41
Nitrosyl chloride	44-13	218
No-flash fuse igniter	01-17	10
Nypene	43-89	210
Oil of vitriol	01-15	9
Oleic acid	43 8	188
Overflow delay	03-9	27
Paper diaphragm delay	03-6, 03-7	26
Paraffin	02-2, 41-3	11, 183
Pen:		
Boobytrap	27-10	116
Firearm	32-18	179
Incendiary	02-20, 02-21	19
Pentalyn G	43 86	209
Pentolite	14-15	45
Percussion:		
Firing device	25-16	89
Fuze	24-5	70
Primer	11-7	38
PETN	14-9	43
Phenol	43-40	198
Phenolic resin	44-27	223
Phenylacetaldehyde	43-55	201
Phenyl phosphite	43-28	196

<i>Abstract</i>	<i>Page</i>
Phosphorus:	
Chlorides	196, 217
Yellow	206, 214
White	6, 200, 224
Picric acid	45
Pinene	212
Pine oil	212
Pipe boobytrap	117
Pistols	168, 171 to 173, 175
Plastic explosive	44, 46
Potassium chlorate	4
Potassium permanganate	8
Pressure:	
Firing devices	80, 81, 82, 84 to 86, 88, 93
25-6, 25-8, 25-9, 25-11 to 25-13, 25-15, 25-21	
Fuzes	68, 69, 75
Release boobytraps	122, 123
Switches	95, 98, 107
Primacord	67
Primary high explosives (<i>See</i> <i>also</i> specific material)	40 to 41
Primers	38
Projected demolition charges	52
Proknocks for fuel	214 to 224
Pull:	
Firing devices	80, 83, 86, 87; 90 to 92
25-6, 25-10, 25-13, 25-14, 25-17 to 25-20	
Fuzes	69, 71, 73
Igniter	9
Switches	96, 100, 104, 106
Pyrogallol	189
Quartz dust	184
Quinoline	194
Radio boobytrap	110
RDX	42
Recinoleic acid	205
Recoilless gun	177
Resin, phenolic	223
Rifle	174 to 175
Rocket launcher	176
Rosin	187, 188, 191, 198, 210
43-4, 43-9, 43-16, 43-43, 43-87, 43-88	
Ester	223
Oil	211
Rubber delay	25, 29
Safety, explosive	48
Safflower oil	32
Salicylic acid	202
Sawdust	11

Abstract

Secondary high explosives		
(See also specific material)	14-1 to 14-22	41 to 47
Shaped charges	22-1, 22-12, 22-13, 22-19, 22-20	51, 56, 57, 63, 64
Shotguns	32-2, 32-8, 32-17	169, 173, 179
Shotshell	33-1, 33-2	180, 181
Silicon tetrachloride	43-71	205
Silver nitrate	01-7	6
Small arm:		
Ammunition	33-1, 33-2	180, 181
Ballistics	31-1	167
Weapons (See also specific item)	32-1 to 32-18	168 to 179
Soap, incendiary	02-11, 02-18	14, 18
Sodium chlorate	01-3	4
Sodium peroxide	01-1, 01-2	4
Soviet devices (See specific device.)		
Spikes, barbed	27-21, 27-22	125
Spontaneous combustion (See also specific material)	04-1 to 04-4	30 to 33
Squib, electric	11-6	37
Stab primer	11-8	38
Steel cutting	21-2	50
String fuse	23-2	66
Styrene	43-2, 43-74	186, 206
Submachine guns	32-4, 32-16	170, 178
Sugar	01-1, 01-3, 43-104	4, 214
Sulfur:	01-13	8
Dichloride	44-5	216
Monochloride	44-6	216
Trioxide	44-4, 44-12	215, 218
Sulfuric acid	01-15, 43-37, 43-73	9, 197, 206
Switches (See also specific item)	26-1 to 26-21	94 to 107
Tar	43-46	190
Telephone boobytrap	27-2, 27-6	109, 113
Tetryl	14-3	41
Tetrytol	14-20	46
Thermite igniter	01-10	7
Thermite incendiary	02-15	16
Timber cutting	21-1	50
Time (See Delay.)		
Tipping delays	03-10 to 03-12	28, 29
TNT	14-1, 22-7, 22-21, 22-22	41, 53, 64, 65
Toluenesulfonic acid	43-5, 43-16, 43-56, 43-57	187, 191, 201, 202
Toluenesulfonyl chloride	43-10, 43-15, 43-31, 43-61, 43-64, 43-68	188, 190, 195, 200, 204, 205
Toothpaste tube, explosive	29-4	158
Trip mechanisms (See also Pull firing devices)	25-17 to 25-19	90 to 92

<i>Abstract</i>	<i>Page</i>
Tung oil04-4, 43-22, 43-38, 43-57, 43-62	33, 193, 197, 202, 203
Umbrella boobytrap27-16	121
Varnish, electrical insulating ..43-91	211
Viet Cong devices (<i>See</i> specific device.)	
Vinyl acetate43-61, 43-83	203, 209
Watch switch (<i>See also</i> Clock switches)26-12	101
Water ignition01-16	10
Water mines28-31, 28-32	152, 153
Wax02-8	13
Weapons, small arms (<i>See</i> <i>also</i> specific item)32-1 to 32-18	168 to 179
Wheel firing device25-21, 26-20	93, 107
Whistle boobytrap27-14	119
Wine bottle cone charge22-1	51
Zinc oleate43-54	201

By Order of the Secretary of the Army:

HAROLD K. JOHNSON,
General, United States Army,
Chief of Staff.

Official:
J. C. LAMBERT,
Major General, United States Army,
The Adjutant General.